

# THE MECHANICS OF WEB SPREADING

by

David R. Roisum, Ph.D.

Finishing Technologies, Inc.  
Neenah, Wisconsin

## ABSTRACT

Web spreading systems are governed by a universal set of web handling principles such as bending, minimal energy path, normal entry, and traction. These laws, which apply for all web materials and spreading systems, can be used to understand the influences which affect spreader operation.

This report covers the mechanics of spreaders such as: bowed rollers, dual bowed rollers, concave rollers, expander rollers, D-bars, Pos-Z™ bars and more. Also covered are spreader design considerations and troubleshooting techniques.

## INTRODUCTION

In a perfect world, there would be little need for spreading. In this world, the web would be manufactured uniformly flat and would remain so through subsequent handling. The realities are however quite different. Spreader are required on most web processes to prevent or remove wrinkles, to widen a web, or to separate slits during winding. They are used in the converting of a variety of materials including film, foil, nonwovens, paper and textiles. However, they are also found in manufacturing as well. Forming wires and drying felts are just a few examples where spreaders are required on 'endless belts' to keep them flat.

There are many types of spreading systems in common use including the bowed roller, dual bowed rollers, concave rollers, expander rollers, D-bars and Pos-Z™ bars. Some have a single element, while others have two or more elements. Some spreaders can be adjusted for local effects, while others can only be adjusted for overall spreading, or may be completely fixed in shape.

Despite their varying appearance and their many diverse applications, all spreaders follow a universal set of web handling principles that govern their operation.

Understanding these principles allows us to make the most appropriate choice of spreader for a particular application, and then to operate that spreader most effectively. In doing so, we will see improved manufacturing and converting efficiency, while at the same time reducing waste due to causes such as wrinkles, foldovers, and stuck rolls.

Indeed, immediate gains can be made by removing so called 'spreaders' such as wormed rollers and cigar shaped rollers which actually contract the web as we shall see. Other common pitfalls include undersized spreading systems that may not remove wrinkles or separate slits, and oversized spreaders that cause instabilities in the web's edge position. Finally, even well designed systems may not do the job if the bow is pointed in the wrong direction for example.

## WEB HANDLING PRINCIPLES

Perhaps the single most important web handling principle which governs spreading systems is the Normal Entry Law<sup>1,2</sup>. As seen in Figure 1, a web will seek to enter a downstream roller at a right angle to the roller's axis at the point of first contact. If for a variety of reasons the web is not currently entering at a right angle, it will move sideways at an ever decreasing rate as seen in Figure 2. This universal principle not only governs spreading, but also describes web behavior at misaligned rollers, guides, and winders. Similarly, the web will also tend to exit a roller in a normal direction. This normal entry/exit principle will be used later to help determine the path of a web through a machine.

An important exception to the normal entry law however, is that it applies only when there is no slippage between a web and its roller. Thus, while it would not describe behavior at a sliding spreader such as the D-Bar or Pos-Z, the web will enter and exit at right angles to the non-slipping upstream and downstream rollers. In any case, traction is such an important parameter that anything that improves traction should also improve spreading. Traction is increased by the variables shown in Table I<sup>3,4</sup>.

**Table I - Traction and Spreading Can Increase with:**

<u>Direction Variable</u>	
Increasing	Friction Coefficient
Increasing	Porosity
Decreasing	Roller Diameter
Decreasing	Speed
Increasing	Tension
Increasing	Wrap Angle

Another important web handling principle for spreaders is the forces that can move a web sideways. There are three distinct spreading mechanisms, but they are often seen in combination on any spreader type. As seen in Figure 3, the lateral force is the most intuitive, where an outward CD tension at a spreader will consequently move the web outward. However, in-plane bending (ZD moment) applied at a spreader will also move a web sideways in a similar fashion. Finally, there is the folding mechanism which displaces the web sideways through simultaneous folding (CD moment) and twisting (MD moment). Folding is the basis for most dual element spreaders. Folding/twisting is also the most powerful because the web isn't as stiff with this mechanism than it is with lateral forces and in-plane bending.

Another constraint with in-plane bending is that it must always be accompanied by sufficient line tension to keep the web taut everywhere. As seen in Figure 4, if pure bending is applied to a web, the slack side will simply sag or flop out of control. As the line tension is increased however, more of the web's width is under tension and the amount of slack web is reduced. Finally, there is a critical minimum line-tension that ensures that the entire web is under tension which can be calculated from simple beam formulas for long span/width ratios.

While it might be surprising to some, the web really does behave much like a beam, albeit a very tall and skinny one. Thus beam or better yet membrane theory is used to analytically model many web handling situations such as spreading. Rather than focusing on math however, this paper is intended to help the reader visualize spreading based on simple principles. One of these principles, borrowed from beam theory, is that the path of a web through a machine will be smooth and gentle curve. With this background, we can now explain the operation of several spreading devices.

## THE CONCAVE SPREADER ROLLER

The simplest and least expensive spreader is the concave roller. As seen in Figure 5, this spreader is a conventional roller whose diameter at the ends is slightly greater than at the center. In its ideal configuration, the diameter profile of the roller is cut as an arc of a circle. However, a simpler version can be made for unslit webs by cutting a roller with conical ends and a cylindrical center. Finally, the simplest of all arrangements is to add a couple of wraps of tape to the ends of a straight roller. Taping straight rollers is only successful on narrow unslit webs, but can be highly effective in that limited application however.

Sizing the diameter ratio is application dependent. However, a rough starting point would be a reduction of diameter at the center of about 10% of the MD strain induced by web line tension or draw control. For example, this would be a 0.020" diameter reduction on a narrow 2" diameter roller running a very stretchy film, nonwoven or tissue grade at a 10% strain. Clearly a spreader roller for this example would be quite easy to manufacture. However, a 10" diameter roller running a flat paper grade at 0.2% strain would require only a 0.002" diameter difference to cause moderate amounts of spreading. Manufacturing a spreader roller for this flat paper example to a controlled profile would be extremely difficult at best.

From these two examples, we can immediately see that the concave roller is limited to stretchy materials due to diametral tolerances of roller manufacturing. However, the flat paper example also illustrates we can inadvertently induce spreading effects on *any* roller by unintentional and tiny diameter variations. Unfortunately, those 'spreading' effects will be unpredictable and nonuniform, and span both spreading and contraction across the same roller.

Understanding how a concave spreader roller operates begins with surface speed variations across the roller. Any solid roller will have a *constant rotational speed (rpm)* across its width. However, it will have a *varying surface speed (fpm)* that is proportional to the local diameter at every position. Thus as seen in Figure 6, the surface speed of the concave roller is higher at the ends than in the center. This surface speed difference causes an ingoing web tension distribution that is shaped similarly to the speed profile. More precisely, the ingoing tension distribution is a superposition of the nonuniform surface speed induced tension profile onto the constant web line tension.

The last two schematics in Figure 6 describes the mechanism for concave roller spreading. For illustration purposes we will look only at the left half of a center slit web, where the unshown right half mirrors the left. The same principles also apply to arbitrarily slit or unslit webs. The top edge of the schematic web is the contact line with the spreader, and the bottom edge is the upstream roller.

The first step is to replace the nonuniform tension distribution with an equivalent force acting at the centroid of the web half (quarter point of the machine) and a bending moment using the parallel axis theorem. The central force merely makes the web longer, and doesn't enter into the spreading picture until we discuss Poisson contraction in a later section. The bending moment definitely has an effect on the shape of the web however. As seen in the figure, the clockwise moment causes the web to rotate clockwise toward the machine centerline. Something else must be going on here, because the inward movement is obviously in the wrong direction for spreading. More importantly, the web edge doesn't enter at a right angle to the roller axis as required by the normal entry law.

This something else is the outward lateral force that is missing. We know that this must exist for two reasons. First, it is the only remaining load type from our Figure 3 discussion that can move a web sideways (remember the bending moment is already accounted for). Secondly and more intuitively, it is quite reasonable to expect that an outward force must be present in order to move the web outward. Now when we superpose the outward lateral force onto the central MD force and clockwise moment, we end up with a shape which meets the normal entry and exit laws and does indeed cause spreading. While it might be tempting to conclude that only a lateral force is present, the absence of the bending moment and lateral force combination will not conform to the normal entry law as the reader will again verify from Figure 3.

This subjective description of the behavior of concave spreaders is simplified as much as possible while retaining the essence of its mechanics. Now we can understand why a cigar shaped roller would actually contract the web because its effects are opposite to those of a concave spreader. As the reader may suspect however, many subtleties have been left out. An analytical description which quantifies friction forces, stresses and displacements requires complex models. Only at considerable effort in research centers<sup>7</sup> have custom computer programs for spreading been developed which yield design information such as spread magnitudes and web stresses as shown in Figure 7.

## **THE BOWED SPREADER ROLLER**

If numbers are any judge, the ubiquitous bowed spreader roller is a very important spreader for wide webs. The bowed roller is most often referred to (improperly) by the Mt. Hope roll trade name, or more formally as a curved axis spreader roller. As seen in Figure 8, the bowed spreader has a curved stationary axle upon which a rotating sleeve(s) is mounted in numerous bearing sets. The axle may have a fixed bow, or can be variable through clever design arrangements such as split axles. The sleeve is typically a one-piece flexible tube of a soft synthetic composite. For high wear resistance and better cover life however, the sleeve may consist of numerous narrow metal rings. The 'rubber' sleeve is usually grooved to reduce air entrainment and thus improve traction, and metal sleeves may be tungsten carbide coated for abrasion resistance and traction. Finally, the bowed roller may be used in powerful dual element spreaders which will be described in a later section.

Since the bowed roller is more complex than other spreaders, there are more design considerations. For example, bearing design becomes very important on bowed rollers which may have dozens of bearing sets which are hard to replace, in contrast to conventional rollers which have only two bearings that are easy to get at. Also affecting bearing design is rpm limitations, lubrication, and the desire for minimal bearing drag. The application engineer must size the drives for motor driven spreader rollers, or size the tension upset on web driven spreader rollers. The torque to drive the roll is composed of bearing drag and sleeve hysteresis during constant speed, with an additional acceleration component from bearing and sleeve inertia during speed changes.

The synthetic sleeves are highly engineered composites. They must provide a reasonable tolerance to wear, bumps, cuts and other damage which is endemic to the industrial environment. The sleeve material must also have a minimal hysteresis because the continual flexing as it rotates around the curved axis can cause increased roller drag, thermal degradation and fatigue. The sleeve must hold its shape to avoid disturbing the spreading uniformity due to diametral variations. Also, loose sleeves are a common problem resulting from improper fits, centrifugally induced creep or thermal expansion. A loose sleeve will shift eccentrically and can cause severe spreader roller vibration. This tendency is exacerbated because spreader rollers are not dynamically balanced, and operate through resonance on high speed winders.

The axle serves two primary functions. First, it is the structural backbone of the spreader. Most of the effective bending stiffness of the spreader comes from the axle rather than the cover. The axle largely determines weight, deflection and critical speed. The second function is to determine the shape of the spreader. A critical aspect in manufacturing spreader roll axles is to maintain a very uniform in-plane (no twisting) arc of a circle (constant radius of curvature). The two most common methods to form the straight axle stock into an arc is to bend (three-point, four-point, or against a template) in a brake press, or to roll in a roll bender. While bending may result in less axle twisting, rolling may result in more uniform curvature.

Sizing a spreader roller involves picking a length corresponding to machine width; diameter determined by deflection, critical speed, and bearing rpm considerations; and finally bow. By convention the bow shape is an arc of a circle as shown in Figure 9. Specifying a bow is often as the distance between the chord and the arc of the roll at its center. This is sometimes expressed as a %bow, which is the bow distance divided by the face length. However, %bow may not translate well for large length changes. A better nondimensionalization of bow and length is by calculating the radius of curvature as:

$$(1) \quad r = \frac{L_c^2 + 4b^2}{8b} \quad \text{where} \quad \begin{array}{l} r = \text{radius of curvature} \\ L_c = \text{cord length} \\ b = \text{bow magnitude} \end{array}$$

or for large radii as

$$(2) \quad r = \frac{L_c^2}{8b}$$

Once a selection is made for an appropriate radius of curvature for any particular application, such as unslit paper, then this value would be applicable for any width machine. However, the rub is that design guidelines for bows are almost nonexistent. Thus, one may have to use previous experience to guide bow selection. One example is a 0.125% bow for wide paper winders in the pre-slitter position and 0.5% bow for the after

slitter position. Stretchy grades could probably use more. More often than not however, bows have erred on the excessive side, especially for stiff materials (eg paper) and on narrow machines (<2m).

Perhaps the reasons bow guidelines are not widely available is because the spreading mechanism is complicated by material considerations such as anisotropic moduli, web/roller traction and multiple slit webs. Even sophisticated computer modeling, such as in Figure 10, doesn't currently model anisotropy and slits. However from modeling, experiment and experience we know that spreading is very traction dependent. Figure 11 shows how spreading increases from zero at no bow to a maximum at the onset of slippage. After which, further bow increases will reduce spreading, and may even contract the web<sup>8</sup>. Thus, it may be better to err on the side of too little bow rather than too much. Unfortunately, small bows are much more difficult to manufacture to an accurate profile.

Setting up a bowed spreader roll can even be more controversial than selecting a bow. Conventional teaching is to place the spreader such that the entering/exiting span length ratio is about 2:1 as shown in Figure 12. Later we will see that the reason for placing a spreader closer to the downstream roller is to retain more of the hard fought spread. Another area of controversy is the desirable wrap angle as seen in Figure 13, which is normally taught to be 15-45°, with at least one author claiming up to 180° is even better<sup>9</sup>.

The final area of setup controversy is the desirable bow orientation. Experience teaches us that the bow should be pointed downstream in a direction perpendicular to the bisector of the wrap. However, adjustments from this nominal orientation can be used to compensate for a baggy center or slack edges. As seen in Figures 14 & 15, a baggy center can be tightened by rotating the bow into the web. As the bow orientation is turned more into the sheet, the path that the center of the web must take is longer than the edges, and consequently tighter. Since the web tension/draw control sets the average tension across the width, the edges will loosen at the same time the center tightens in order to maintain that average tension. Conversely, slack edges can be tightened by rotating the bow out of the web, but care must be used in this direction to avoid edge wrinkling.

It is important to note that the web sees a different bow magnitude and a different bow direction than the specified bow and pointer direction that the spreader manufacturer provides. This is because web tension and gravity deflection both modify the bow's direction and magnitude. For example, a spreader pointing upward will see a net bow which is the pre-bow minus gravity deflection while the same spreader pointing down will see a net bow which is the pre-bow plus gravity deflection. To determine what pre-bow should be supplied to achieve a desired net bow, and to determine what direction to aim the pointer to result in a desired bow direction requires simple vector math. This is a little more complicated for split axle designs which are less stiff in the bow direction than perpendicular to the bow.

The mechanics of bowed roller spreading follow the same web handling principles as do all other rollers, including the normal entry law for the non-slipping case. As seen in Figure 16, the center of the web travels exactly in the MD, while the edges travel perpendicular to the axis of the roller at the edges. While the surface *speeds* are uniform across the web (for a uniform diameter roller), the surface *velocities* are not. The velocity vector at any position has both an MD tension component and a lateral CD tension component. The MD velocity distribution is maximum at the machine centerline and

steadily decreases toward the edges, which causes an outward rotation of the web. The CD velocity is zero at the machine centerline and increases as one progresses outward, which causes an outward lateral displacement of the web. Thus while rotation fought displacement in the case of the concave roller, rotation works with displacement in the case of the bowed roller.

In addition to rotation and displacement, there is also a carry out effect that increases bowed roller spreading with increased wrap angle. As seen in Figure 17, the web exits a point further outward than where it entered. The carry out effect increases from zero at no wrap to a maximum at 180° wrap, but is reduced very slightly with bow orientations away from the ideal. From simple trigonometry, the magnitude of this effect can be quite easily calculated. For the somewhat extreme example of a 180° wrap on a 25 cm roller with a 50 meter radius of curvature on a 5 meter wide machine; the carry out effect would be an increase of width of about 0.5%. Thus, spreading can be improved by increasing the wrap angle which increases both traction and carry out.

Putting it all together we can draw the path of the web through a machine as shown in Figure 18. The web exits normally from the upstream roller at a width  $W_0$  which is known, bends outward and enters the spreader at a right angle at all positions, and finally rotates inward to become perpendicular to the downstream roller. Intuitively one might conclude that the amount of spreading is determined by the width at the spreader ( $W_1$ ). However, it is the width at the downstream roller ( $W_2$ ) that actually determines the amount of spread that will be carried downstream.

Unfortunately, only a few conclusions can be made about width relationships without analytical models or experimental measurements. First,  $W_1 \geq W_0$  because of the combined effects of rotation, displacement and carry out at the spreader. Second,  $W_2 \geq W_0$  because a portion of the spread will survive to the downstream roller, depending mostly on the proximity of the spreader to the downstream roller. For spreaders placed very close to the downstream roller,  $W_2 \geq W_1 \geq W_0$ . A note of caution is needed here however. If the spreader is placed too close to the downstream roller, wrinkling can result from the severe stress gradients. For spreaders placed quite far from the downstream roller,  $W_2 \approx W_0$ . In other words, all spreading effects can (and will) be lost given enough distance downstream for reasons which will be discussed later.

## **THE BENT PIPE AND D-BAR SPREADERS**

The bent pipe is second only to the bowed spreader roller in terms of usage. Its popularity lies with its simple construction that can be made in most any shop. Unfortunately, this simplicity often leads to crude manufacturing practices and dubious spreading qualities. The pipe can be bent using 3 point bending, but the result is a curvature and spreading that varies from a maximum at the center to zero at the ends. A more uniform curvature can be made either by rolling the pipe, or by bending it in 4 point bending and cutting off the ends.

A D-bar spreader takes its name from the characteristic 'D' cross-section of the bar as seen in Figure 19. The only functional difference between a D-bar and bent pipe spreader is that the D-bar's shape can be adjusted by intermediate jacks. With this adjustment the operator can spread a local baggy or wrinkled spot, or open up a particular slit position. The problem however, is that the bar soon ends up looking like a snake after several adjustments, which adversely affects spreading uniformity.

The operation of the bent pipe or D-Bar spreader is based on two distinct principles. The first is to minimize the web's strain energy. This can be loosely interpreted as minimizing the path length through the spreading system, as shown in the example Figure 20. Here, a web at the quarter point may wish to take path A straight through, or B or C with increasing offset/spread. While it might appear that the straight path A is the shortest as seen in the plan view, it is the longest in the end view because that portion of the spreader protrudes into the web run farther than paths B & C. Not surprisingly, this means that path B, which has some spread offset, is the shortest and least energetic path. A good spreader setup will have an strain energy versus spread curve that has a minima located at a slight positive outward displacement.

The second pipe/D-bar principle is bending toward the low friction side of a individual slit web as seen in Figure 22. This may either increase or decrease spreading depending on several variables including bar shape, average tension, local tensions, and local coefficients of friction. Thus, if there are tight and loose areas of the web as manufactured, the spreading will be inconsistent from one position to the next. Furthermore, if these vary with time (MD) as well, the web will dither and wander. What saves us in these situations is the tremendous in-plane bending stiffness of the web that helps to keep spreading small and somewhat stable.

Like most spreader types, there are no models and few application guidelines. One exception is for D-bars on wide paper machine winders which should have a 5 mm penetration into the sheet run and a 0.2% bow<sup>10</sup>. A final limitation of pipe, D-bar and other sliding spreaders is that web scratching may be unacceptable for many grades, particularly those that are coated. Indeed, even the hardened steel bar may wear out prematurely on paper grades which can be so abrasive that they spark going over the bar.

## **CURVATURE EFFECTS ON SPREADING**

Local curvature affects local spreading of concave rollers, bowed rollers, D-bars and dual spreaders. In most cases, we would like the curvature to be constant across the face so that spreading strength would also be uniform. However, even tiny imperfections in shape resulting from manufacturing or by local adjustment can cause spreading problems. Figure 22 gives an example of a D-bar spreader which is pretty much uniform in curvature on the right half, but contains a slight kink on the left half. This picture is quite exaggerated as the kink can be subtle enough to escape casual observation, yet still cause quality problems. If we use the traditional radius of curvature concept, the good spreading half has a center of curvature located on the spreader side of the web, and the kinked half has its center on the opposite side. By mathematical convention (but contrary to intuition), the kinked side has a positive curvature and the good side has negative curvature. Instead of curvature however, in this article we will present a superior alternative to shape description.

We start by profiling the spreader in 10-20 positions across the face. One way to do this is by measuring the gap between the spreader and a strung wire. Next we take a numerical first derivative of spreader shape as seen in the second graph of Figure 22. The utility of the slope or 1st derivative is that it indicates the preferred path of a web at every point. A positive slope on the left side of centerline indicates the web will prefer to move outward, while a negative slope on the right side of centerline will also tend to move the web outward. At this point one might conclude that there will be spreading on the left half of our example spreader, as all points of the web will tend to move outward as given by the preceding rule. However, outward movement everywhere is not sufficient to



guarantee spreading everywhere. For example if two neighboring points move outward the same amount, there will be no spreading between them.

A final step is to take yet another numerical derivative, as shown in the bottom of Figure 22. Again by calculus convention but not by intuition, the web contracts where the 2nd derivative is positive and vice versa. Thus, even though our spreader shape tapers outward at all locations, and even though the web moves outward at all locations, there can still be local contractions. **Local spreading strength is proportional to the 2nd derivative of the spreader's shape at that point.** While the 2nd derivative and curvature are related as

$$(3) \quad \kappa = \frac{\pm \frac{d^2y}{dx^2}}{\left[1 + \left(\frac{dy}{dx}\right)^2\right]^{3/2}}$$

strong spreading descriptions elude the traditional curvature concept. Indeed, how can it handle the infinite curvature of ambiguous sign on the minute straight segment located at the quarter point of our example?

While this involved mathematics may seem academic, it has powerful implications for quality control on curved spreader systems. If we want spreading to be uniform across the width, this means that the 2nd derivative of bar position/shape must be constant across the entire width. Yet this is very difficult to do, something like driving a car blindfolded by listening for the tires hitting the gravel on either side. The practical result is that even modestly uniform spreading requires extremely tight quality control on spreader shape.

## THE DUAL BOWED ROLLER SPREADER

The dual bowed roller spreader uses two conventional fixed bow spreaders in tandem to produce some very powerful spreading effects. Its primary use is after a slitter section which cuts many narrow webs. The dual bowed spreader is often mounted on a pivot so that the spreading magnitude can be adjusted for a varying number of slits by varying the wrap angle on the bars. Unfortunately, it is a more costly spreader because there are two bowed rollers, which may require drive motors, and a pivoting stand. A variation of the dual spreader is bowed roller in the first position and a D-bar in the second position which allows some adjustment of spread profile.

In its classic setup as seen in Figure 23, the pivot is located on the midpoint of a tangent connecting the upstream roller (typically an after slitter roller) and the downstream roller (typically the 1st winding drum). Both spreader roller bows are oriented perpendicular to the incoming and outgoing sheet runs, and thus are parallel to themselves. The first bow points out of the web, while the second points into the web. The bow orientations may need adjustment to maintain perpendicularity whenever a large pivot adjustment is made.

The primary spreading mechanism of the dual roller spreader is an outward geometrical folding and twisting of the web. As seen in the plan view of Figure 24, the web(s) are twisted in the entry span to the first roller. Then the web paths are redirected to diverge outward by folding over the first roller. The outward fanning paths then continue to the second roller. Finally, the second roller folds and then twists the web(s) back

parallel to themselves. The reason why the dual roller spreader is so powerful, is that the web is being folded and twisted instead of bent sideways, which are much easier maneuvers for the web to follow than the in-plane bending of other spreaders. The astute reader may wonder why the webs don't appear to obey the parallel entry/exit laws in Figure 24. Rest assured that they actually do, however this can only be seen from appropriate oblique views.

## THE POS-Z™ SPREADER

The Pos-Z™ spreader shares some similarities with the dual bowed roll spreader as seen in Figure 25. First, it is a dual curved element spreader. However, the Pos-Z™ has two *stationary* air floated *bars* instead of two *rollers*. Older designs were drilled fiberglass sleeves which fitted over axles, but are now are hardened metal tubes to increase wear resistance. Though the webs are intended to float instead of slide, porous or uneven webs would occasionally contact the bars, even with very large blowers. Second, the Pos-Z™ is also used primarily after a slitter section which cuts numerous small widths. Third, the dual element Pos-Z™ is also an expensive spreader.

However, the similarities end there. First, newer Pos-Z™ spreaders are adjusted by several jacks which change the bow magnitude. Second, Pos-Z™ bows point upstream and *parallel* to the incoming and outgoing web runs. Third, while the Pos-Z™ is also a twist/fold spreader, its operation is governed strictly by geometry instead of traction and the normal entry rule. The easiest way to demonstrate the Pos-Z™ principle is to 's-wrap' two parallel but angled pencils with a long strip of paper as seen in Figure 26. The outward offset results from wrapping the bars on a very slight helix angle. The spreading magnitude of the powerful Pos-Z™ increases with bow magnitude, wrap angle, bar diameter, and bar separation.

The air float nature of the Pos-Z™ has several disadvantages. First, the low pressure (5 psi) air blown through numerous holes in the bars can float only low tension (<5PLI) grades. Second, in some applications the air film is unstable, making it difficult to meet industrial noise standards. Third, Pos-Z™ spreading can be erratic if a tight portion of a web collapses the air film between the web and bar, causing the web to skid sideways slightly in response to the induced moment. Nonetheless, the Pos-Z™ is simultaneously a most powerful yet gentle-to-the-web spreading system.

## COMPLIANT COVER ROLLERS

The compliant cover roller, as seen in Figure 27, is a straight roller which has a special grooving cut into a soft outer cover. The grooving is undercut at an angle so that the inward radial pressure created by web tension deflects the lands outward, carrying the web with it to supposedly accomplish the spreading action. It is a very popular spreader on slow and narrow web converting processes because of its economy and simplicity. However, there appears to be no published research model or measurement establishing its benefits. Additionally, this author fails to see how the compliant cover roller can accomplish a spreading action for reasons of symmetry and CD uniformity.

As seen in Figure 28, the web does indeed deflect outward as it approaches the web/cover tangency and continues to deflect outward until it reaches a maximum at the center of the contact area. However, guess what happens on the downstream side? Yes, it would appear that as the pressure is released on the downstream side of the contact

area, the land springs back inward carrying the web with it to exactly the same CD position. This is because the compliant cover roller is symmetrical about the upstream and downstream sides, which is not true of any other spreader. One way the spreader could be unsymmetrical is if the web resists outward motion by slipping on the ingoing half of the contact area, which could easily happen on stiff webs. However, this would tend to cause the web to contract or buckle on the outgoing half of the contact area, which would be highly undesirable. There is also a slight asymmetry to the nip in the presence of rolling friction or other torques, but its effects are not clear.

The other reason the compliant cover roller may not operate as intended, is due to the uniformity of CD movement. That is, if each land moves the web outward the same amount, spread would only occur at the center between the innermost grooves. True, there are evolutions of the grooving patterns which increase deflection from the centerline outward, but they are not a common style. Thus, while the compliant cover may be beneficial (many people in the paper, film and foil converting industries swear by them), we do not see how it functions as a spreader. This is yet another case where both vendors and customers may have failed to do their homework to establish converting equipment performance.

## **SLATTED EXPANDER SPREADER ROLLERS**

In one version, the slatted expander spreader has numerous elastomeric bands connecting across the machine to adjustable cams on each end. These bands, as seen in Figure 29, are arranged to approximate a cylindrical roller. A variation on the theme is to have half-width slats that slide at their junction in the middle. The principle of operation is really quite simple. The web's ingoing tangent is on the short band side, and the outgoing tangent is on the long band side of the spreader. This is in contrast to the compliant cover roller whose ingoing and outgoing widths are similar. Grade changes for the slatted expander roller can be made by either cam orientation or cam side angle adjustments.

While the expander roller is a very powerful spreader, it does have some severe limitations. First, speed is limited to a few hundred mpm before the centrifugal force pulls the elastomeric bands away from the roller. Second, the bands are quite tender compared with most covered rollers so that replacing worn or broken bands could be a maintenance nuisance. Thus, the slatted expander roller is best suited to low speed converting operations on stretchy grades of nonwovens or textiles.

## **EDGE PULL WEB STRETCHERS**

Edge pull stretchers are the most powerful spreaders, and are sometimes capable of increasing web width by hundreds of percent. Obviously, strains this large are limited to very stretchy materials such as films, nonwovens and textiles. Web stretcher rollers are a pair of narrow, soft covered nipping rollers on each edge of the web. They are canted outward, as seen in Figure 30, and accomplish spreading by the CD component of the rollers' velocity vector. Because the MD component is reduced with misalignment angle, the rollers may need to be driven at speeds greater than web speed. Unfortunately, stretcher rollers impose very violent stresses to the web. This makes it tricky to set up drive speed, cant angle, and nip load to avoid wrinkling or tearing.

A similar edge pull spreader is the tenter, which is ubiquitous in plastic film manufacturing. As seen in Figure 30, the tenter is an endless track which guides a chain

with numerous clips. These clips engage the web at the narrow upstream side, are pulled outward following the shape of the tenter track, and finally released on the downstream side. A primary disadvantage of the tenter is local web distortions near the clips which need to be trimmed away as waste.

## **SPREADERS THAT DON'T AND WHY**

Many times spreading falls short of expectation and need. Sometimes this is due to improper application or setup. In other cases the spreader may be too underpowered to deal with excessive web nonuniformities, inconsistent roller traction, or roller misalignments. The most severe spreading challenge are foldovers, which must be eliminated at the source since they can seldom be removed once formed.

However, a near universal spreading fallacy has led many into the mistaken belief that a spreading function has been provided for. This fallacy is the so-called 'spreading' from spiral grooved rollers. Unfortunately, this perception results from nothing more than a 'barber pole' optical illusion. The spiral grooving, just as the barber pole, has no axial movement of the surface. Thus a web in traction with the spiral grooved roller locks in on the ingoing tangent, is carried around, and finally deposited on the outgoing tangent with absolutely no CD offset or movement. Also, the higher velocity air pumped through the grooves don't aid spreading because the forces are miniscule and actually point inward.

If there is (undesirable) slippage between web and roller, the spiral grooving may spread or contract depending on the direction of the grooves and whether the roller is undersped or oversped. The most common situation is an undersped roller, which can result from too little drive, wrap and tension; or too much machine speed and bearing drag. In the case of an undersped roller, the center 'arrow' formed by the junction of the two different hand leads should point upstream to provide an outward plow. Unfortunately, this is not the way spiral grooving is usually set up because it gives a contracting illusion. Conversely, the oversped roller should be set up so the 'arrow' points downstream.

So what is the best way to set up spiral grooved rollers? First, leave existing rollers just the way they are because it just doesn't make a significant difference. In other words, annular, spiral front, spiral back, spiral center and spiral out will all behave the same in the desirable case of a fully tractive roller. Second, specify new rollers with the least expensive grooving, which is either annular or spiraled in one direction only. Finally, a true spreader may be needed for wrinkle removal, web flattening or slit separation since grooving just doesn't do it.

An even more serious issue is the contractive tendencies of all grooved and raised thread rollers. As a web of a given width is wrapped on a roller with grooving or raised threads, the ends pull inward as shown in Figure 31. This happens because the web tends to conform around the longer surface contour instead of forming a straight section across the width. The raised thread rollers, also known as worm rollers, are the worst because the web will conform to both the top of thread and the bottom of the land, whereas a web may not conform significantly to grooves unless they are wide and the web is of light gage. If the 'grooving' between sectional rollers is too wide however, the web may be sucked into the roller gap until it bottoms out. This is similar to the instability which happens when the edge of a web runs off the edge of a roller.

A simple estimate of the maximum contraction of a web due to grooves is to calculate the arc length of a half sine wave, which is the traditionally assumed cross sectional shape of a model wrinkle<sup>11</sup>, and then converting that value to a strain as<sup>12</sup>,

$$(4) \quad \epsilon_{\text{trough}} \approx \left( \frac{\pi (\text{height or depth})}{2 \times \text{width}} \right)^2$$

For example, given a 1 cm tall by 2 cm wide 'worm' on a 200 cm pitch (1% effective area), the maximum contractive strain would be 0.6%. While this may not appear significant, this is larger than the typical magnitude of spreading. In other words, the worm roll will contract more than a typical paper spreader will spread. This also shows that a spreader may not flatten a web with even a single 1 cm trough.

Another common false assumption is that spreaders will operate in spite of web/roller traction changes. Guess what happens if a concave spreader slips? It turns into a contracter. Conversely, a slipping barrel shaped roller which is normally a contracter becomes a spreader exactly like the bent pipe or D-bar. A slipping bowed roller on the other hand, becomes a spreader if the bow is pointed into the sheet from the nominal (like a D-bar) , and a contracter if pointed out of the sheet.

Though spreaders seldom see such a complete flip-flop in operation, traction changes are still a major cause of web wandering and weave. In other words, a slipping baggy area of a web will track differently than its full tractive neighbors. If the baggy lane changes with time, the edge of the web will wander causing wound roll offsets, interweaving and even edge guide problems. Always remember that every element that touches a web also steers it. This is doubly true of spreaders because they are intended to steer the web in an unnatural direction, namely sideways.

The reason that traction is so important is because the boundary conditions which determine the web's path are different for the cases of tractive, slipping and stationary elements as seen in Figure 32. The fully tractive roller steers the web as determined by the normal entry/exit laws, and the force of the roller against the web has a magnitude which is *less than static friction*. However, the slipping roller steers the web in a direction intermediate to straight ahead and the roller normal, and has a roller/web force which is *equal to dynamic friction*. Finally, the stationary bar does no steering of the web, and has an opposing roller/web force equal to dynamic friction. Thus, if your roller or spreader changes from traction to slipping at any time or location, a whole new set of physics operates which steers the web in a different way. Typically what happens, as seen before, is that spreading is lost on bowed rollers which slip. And the slip doesn't have to be large, microslip is enough to kill spreading.

There are several methods to indicate slippage, with the most direct being a hand tachometer measurement comparing web and roller speeds. In addition to good measurement techniques, there are also other considerations. First, one must measure web speed right over the spreader roller because the web travels at different speeds on adjacent rollers. Second, one must correct the web speed downward by the ratio of the roller diameter to roller diameter plus web thickness because of radius differences.

Two indirect means to detect slippage are also useful. The first is to blue or stain the roller or bar and check for removal of the stain after a short running period. This is an especially good indicator of web nonuniformity problems. Another way to check slippage after the fact is to carefully measure roller/bar diameter after it has been operating for

months or years to see what the wear patterns are. In some situations, more accurate wear patterns can be obtained indirectly by measuring the remaining grooving depth of rollers, or hole countersink diameters on air floated bars, or plating thickness with inductive proximity sensors on coated bars. Typically one finds the smallest diameter, possibly implying the highest slippage, to be near the edges of the web deckle as seen in Figure 33. Edge wear can be caused because the traction to move a web sideways must increase from zero at the center to a maximum at the edges. Thus, the edges would be the first places to slip, and accordingly will see the highest wear.

## THE 'FREE' SPREADER

A 'free' spreader is no magic, rather it is the physics of Poisson contraction. As seen in Figure 34, as a web is stretched under increasing tension, it necks down in width. This decrease in width may translate into flatter webs or better slit separation. Since anisotropic webs have several Poisson ratios, we must be careful to use  $\nu_{12}$ , which is a CD width change resulting from an MD tension change. The magnitude of the CD width change can be calculated as

$$(5) \quad \epsilon_{CD} = -\nu_{12} \times \Delta\epsilon_{MD}$$

For example, a 10 m wide paper web with a poisson ratio of 0.3 with its MD strain increased by only 0.02% ( $\approx 10\%$  tension increase) will have an extra 0.6 mm of width. This is enough for an additional slit separation. Poisson effects are more dramatic on stretchy grades such as tissue run at draws exceeding 10%, where width changes can be easily measured with a tape measure. Effects on stretchy nonwoven grades are truly impressive because Poisson ratios can be 10x that of most materials. One merely needs to increase the tension/draw on some driven roller to get 'free' spreading. Well, almost free. Increasing tensions will increase the propensity to web breaks. Also, once tension is increased in some span it is difficult to reduce the tension further downstream without causing troughs.

## WHY SPREADING IS TEMPORARY

For several reasons, the effects of spreading are ephemeral because they dissipate as the web progresses downstream from the spreading system. The first effect is from the necking of the web as it tries to return to its 'natural' width as seen in Figure 35. This natural width is determined by

$$(6) \quad W_{\text{natural}} = W_{\text{unstressed}} \times \nu_{12} \times (1 - \epsilon_1) = W_{\text{unstressed}} \times \nu_{12} \times (1 - \text{tension/modulus})$$

This web necking is exactly the same phenomenon as specimen necking in a tensile testing machine<sup>13</sup>. Without resorting to measurement or model, St. Venant's Principle indicates all end effects dissipate by ten characteristic dimensions away from a discontinuity. However, the practical reality is that much of the spread is lost in the first web width downstream from the spreader.

A second cause of lost spreading is the random paths taken by different CD positions as the web moves downstream as seen in Figure 35. These random fluctuations, more commonly known as weave, are caused by variations in factors such as traction, alignment, and web uniformity. Mathematicians call this behavior by names such as the Drunkard's Walk, the Random Walk, and Brownian Motion. They would then stochastically model this as a two-dimensional Markov Chain with an absorbing state of

zero spread. The most severe absorbing state is a foldover wrinkle on a roller, which is tenaciously difficult to remove. In layman's terms this means that without spreading intervention, wrinkling and overlaps will become more frequent as the web moves downstream through a converting process. Also, foldovers must be prevented at the source because they can't usually be cured downstream of their formation.

A common cause of weave is camber, which is a variation in the natural length of a web across its width caused by residual strains from the manufacturing process. A narrow web with a camber problem will have an arched in-plane shape when tension is removed, while a wide web will exhibit baggy lanes and tight bands. In any case, a cambered web will become progressively more difficult to keep flat and straight as it moves downstream.

The temporary nature of spreading has two practical implications. First, spreaders should be located quite close to critical processes so that the maximum benefit is retained. Critical processes which demand a flat web include embossing, calendaring, laminating, printing, slitting and winding. Second, several spreaders (and guides) may be needed on long machines with several critical processes. Be careful however, too much spreading could cause problems due to the bistable nature of spreading. Because spreaders pull both edges outward, the web will tend to 'toggle' to one side or another of the machine centerline. While toggling is seldom noticed on wide webs, long narrow webs will tend to run off the edges of rollers if there is too much spread.

## HOW MUCH SPREADING IS NEEDED

How much spreading you need depends on the complex mechanics of your particular application and grades. Thus sizing, specifying and adjusting a spreader is best based on close prior experience. In any case however, use only enough spreading as your application requires. Overspreading (such as excessive bow amounts) can lead to process problems. More specifically, you want to maintain a positive CD tension or positive slit separation at most times and positions because exceptions may cause product waste and production delay. For example, it doesn't matter whether one specifies an *average* wound roll slit separation of 0.5 mm or 1.0 mm, because rolls don't tie together if the *minimum* is greater than zero everywhere. The same principle is true of the spreading of unslit webs. Unfortunately, most spreaders can only be sized/adjusted for average spread.

As seen in Figure 36, the amount of spread has a distribution with an average and a variance. This distribution can be either with CD position and/or time (MD). Thus, while the mode is toward spreading, there may be locations where the spreading briefly drops below zero and may result in troughs or slit overlaps. Using this insight, one can list two possibilities for practical spreading improvement. First, one can increase the average spreading by spreader system selection or adjustment. Second, one can decrease the spread variance. These principles will guide us in the following spreader troubleshooting section.

## HOW TO DIAGNOSE SPREADING PROBLEMS

For spreading diagnosis, we will use a powerful diagnostic technique called FTA (Fault Tree Analysis), which is derived from the science of reliability engineering. The advantage with this approach is that by simple observation and measurement, one can quickly reduce the number of options for any spreading problem situation. A portion of the troubleshooting technique is shown in Figure 37.

The first step needed for application of FTA is to make measurements of spread magnitude. These measurements should be both as a function of time as well as CD position at a convenient downstream roller. Spread magnitude can be measured between slits with photoeyes, or between winding rolls with a feeler gage. Measuring spread on unslit webs, though more difficult, can be done using edge guide sensors, acoustic transmission, or subjectively as baggy lane or wrinkle amplitude. The shape of the probability distribution of these measurements indicates whether to work on increasing the average, or decreasing the variance of spreading. A statistician will be needed for experimental design as well as the analysis to separate CD and MD variance, both of which contribute to minimum spread problems. The last step is to pursue FTA further toward the root cause(s) for the low average or excessive variance. While this procedure may seem involved, it may be needed when 'cut and try' approaches fail.

Finally, we will mention a couple of the numerous special techniques that can be applied in particular situations. The first example is based on preventing wrinkles rather than removing them with a spreader. To apply this technique, follow a wrinkle upstream until you find its first occurrence. The wrinkle will in most cases be caused by misalignment of one of the rollers spanning the first wrinkle appearance. The second example can be used to determine whether a variable spreader is functioning at all. To apply this technique, increase the bow to a safe maximum and observe web flatness or slit separation. Then release the bow completely and look for a resulting change in the web. It is not unusual to find spreaders that are completely inoperable, often due to lack of traction or improper setup.

## **SUMMARY**

Spreading is very important to the product quality and productivity of most converting processes. Though the variety of spreaders and their applications may seem bewildering, they all follow the same mechanics governing web handling systems. The process engineer who understands these principles will be in a much better position to size, select and set up spreaders in a most trouble-free fashion. Also, an appreciation of the limitations of spreading should mean increased attention to upstream processes by manufacturing a more uniform web, keeping the web flat through closer machine alignment, and maintaining tight tension control in all spans and at all speeds. In an ideal world, there would be no need for spreaders.

## **ACKNOWLEDGEMENTS**

I would like to thank Dr. Ronald Delahoussaye of Oklahoma State University and Robert Lucas of Beloit Corporate Research for their assistance in reviewing this paper.

## **REFERENCES**

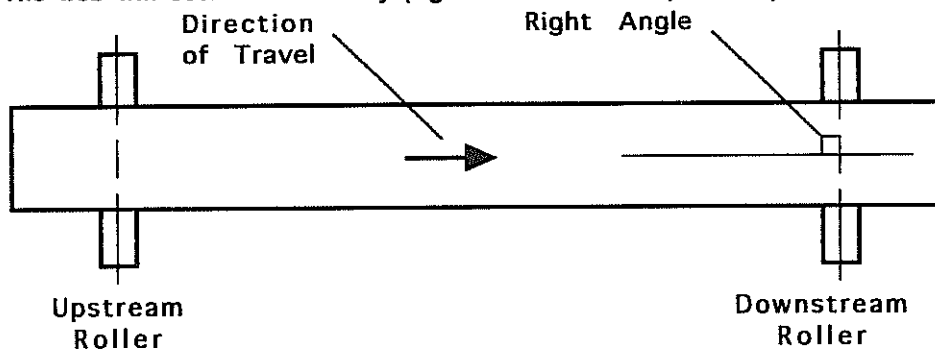
1. Pfeiffer, J. David. "Web Guidance Concepts and Applications." TAPPI Finishing and Converting Conference Proceedings. (October 1977).
2. Pfeiffer, J. David. "Web Guidance Concepts and Applications." Tappi Journal, Vol. 60, No. 12, pp. 53-58. (December 1977).
3. Ducotey, Keith S. "Dynamic Coefficient of Friction Including the Effects of Air Entrainment Between a Roller and Web." M.S Thesis, Web Handling Research Center at Oklahoma State University. (December 1987).
4. Adams, Richard J. "The Influence of Rolls and Reels on Flutter and Windage." Tappi Journal, Vol. 75, No. 11, pp. 215-222. (November 1992).



5. Shelton, John J. "Lateral Dynamics of a Moving Web." Ph.D Thesis, Oklahoma State University. (July 1968).
6. Gehlback, Lars S. and D. M. Kedl and J. K. Good. "Predicting Shear Wrinkles in Web Spans." Tappi Journal, Vol. 72, No. 8, pp. 129-134. (August 1989).
7. Delahoussaye, Ronald D. "Analysis of Deformations, Stresses and Forces in Webs Encountering Spreading Rollers." Ph.D Thesis, Web Handling Research Center at Oklahoma State University. (December 1989).
8. Lucas, Robert G. "Better Spreading of the Web in the Winder - and How to Achieve It." Pulp & Paper, Vol. 30, No. 3. (April 1977).
9. Feiertag, Bruce A. "Selection of Bow for Curved Axis Rollers." TAPPI Finishing and Converting Conference Proceedings. (October 1981).
10. Anon. "D-Bar Spreader Instructions." Beloit Corporation Manual #J 045-10006, October 1973.
11. Friedrich, Craig R. "Stability Sensitivity of Web Wrinkles on Rollers." Tappi Journal, vol 72, no 2, pp 161-165. (February 1989).
12. Shelton, John J. "Machine Direction Troughs in Web Spans and Corrugations in Wound Rolls." Internal Report, Web Handling Research Center at Oklahoma State University. (August 1991).
13. Seo, Y.B. et al. "Tension Buckling Behavior of Paper." Journal of Pulp and Paper Science, vol 18, no 2, pp J55-J59. (March 1992).

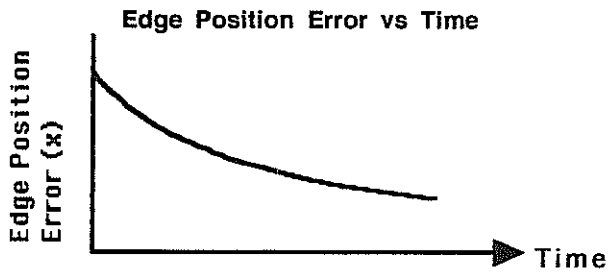
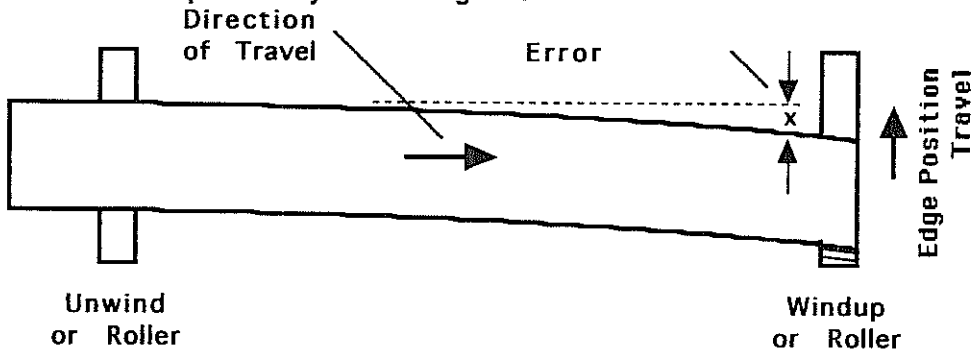
### Figure 1 Normal Entry Law

The web will seek normal entry (right  $\angle$  to roller axis) at the point of contact.



**Figure 2**  
**Getting Normal**

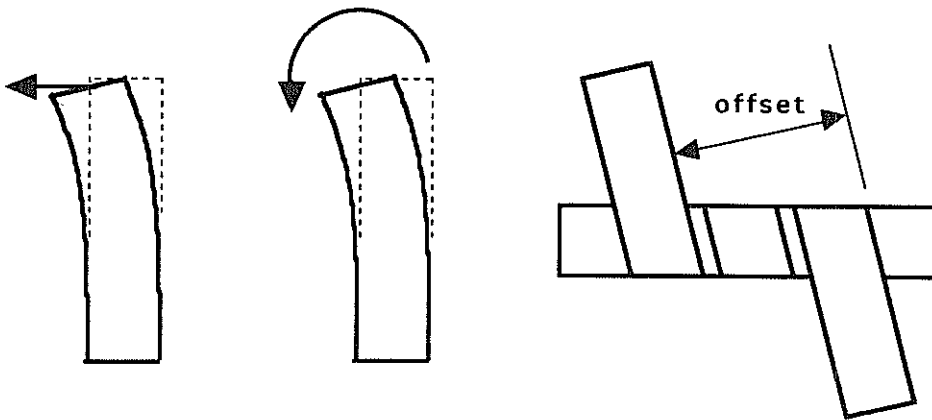
If the web is not currently entering normal to the roller, it will attempt to get there at an exponentially decreasing rate.



**Figure 3**  
**Spreading Forces**

There are three forces that can move a web outward from its centerline.

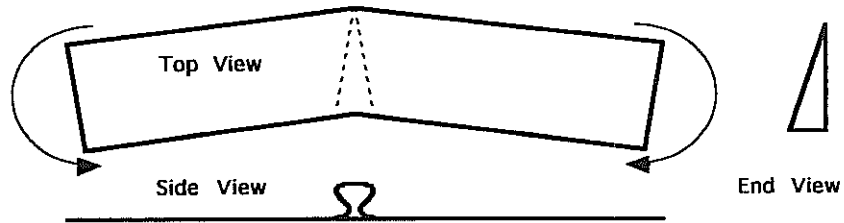
Lateral Force      Bending Moment      Folding



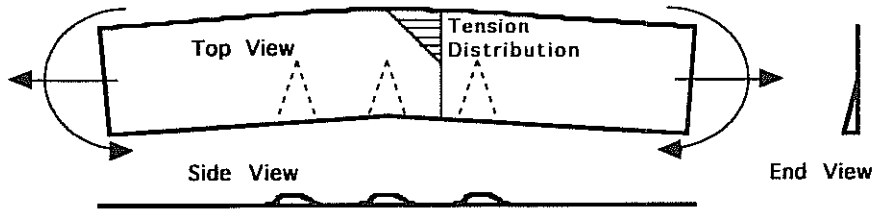
**Figure 4**  
**Combined Bending and Tension**

Bending from spreaders or misaligned rollers, tension from line tension.

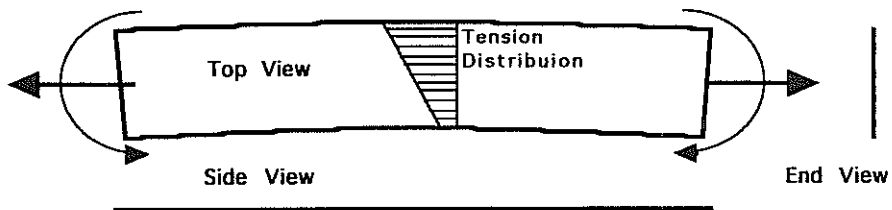
Bending, No Tension



Bending, With Lo Tension



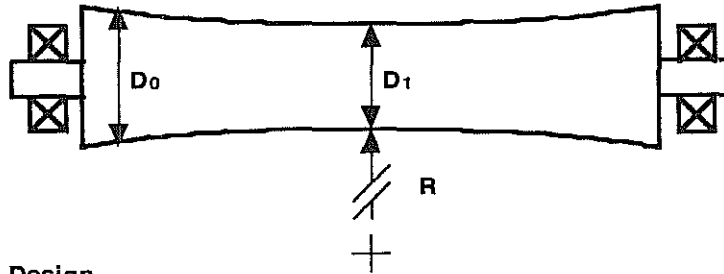
Bending, With Hi Tension



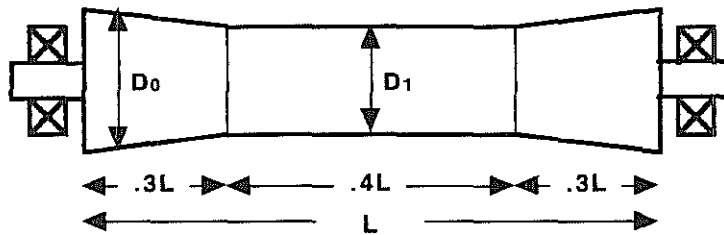
# Figure 5 Concave Spreader Roller

This spreader is a simple roller whose diameter at the ends > the center.

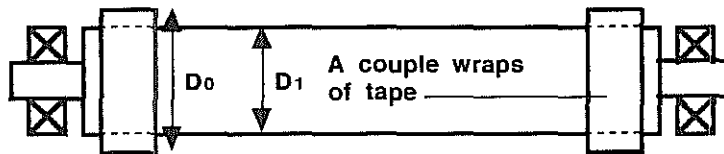
Optimum Design



Simpler Design

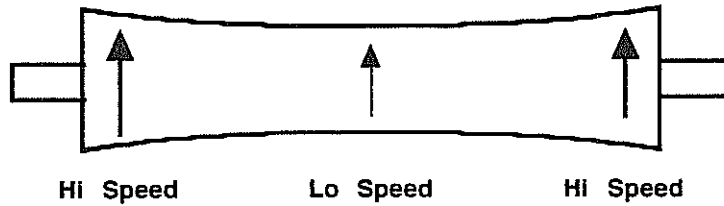


Straight Roller Conversion



**Figure 6**  
**Concave Spreader Mechanics**

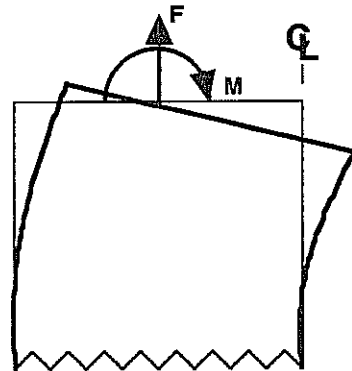
Surface speed variations across the roller induce spreading.  
 Diameter and Surface Speed Profile of the Concave Roller



Resulting Ingoing Web Tension Profile



Induced Moment and Shape

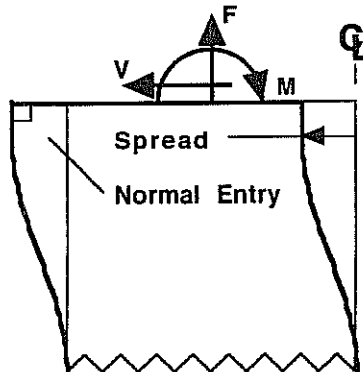


View of Left Half Web Only for Clarity

The tension distribution is replaced by an equivalent tensile force at the centroid and a bending moment.

However, the law of normal entry is violated by the angle of the web at the point of contact with the roller ...

Superposing the Lateral Force gives the Final Shape

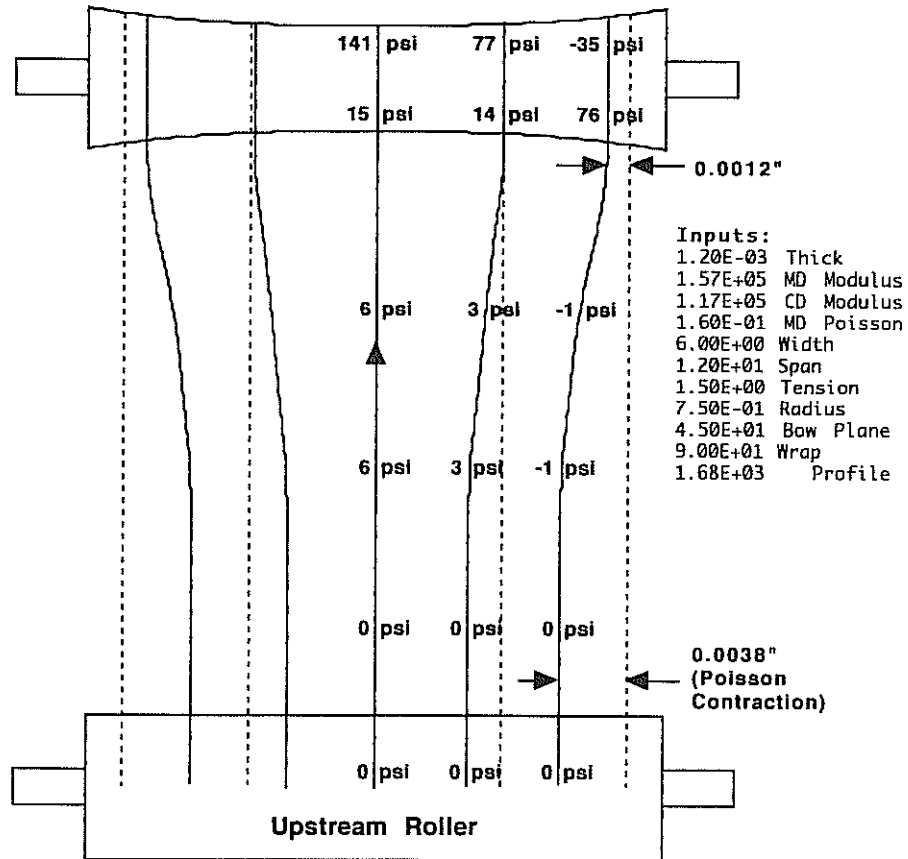


View of Left Half Web Only for Clarity

The only way to get the web back to normal entry is by superposition of an outward lateral force.

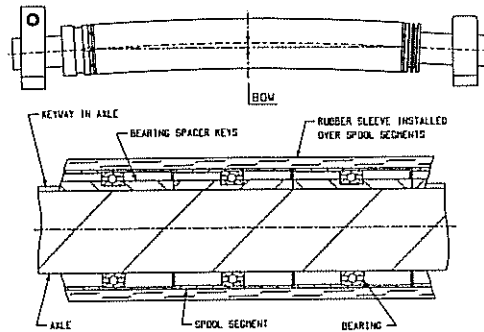
Thus, the resulting shape from a combination of a nonuniform tension distribution and lateral force meets the normal entry/exit laws as well as observations of spreader behavior.

**Figure 7**  
**CD Web Stress/Strain in a Concave Spreader Roller**  
 Data Courtesy Dr. Ronald Delahoussaye



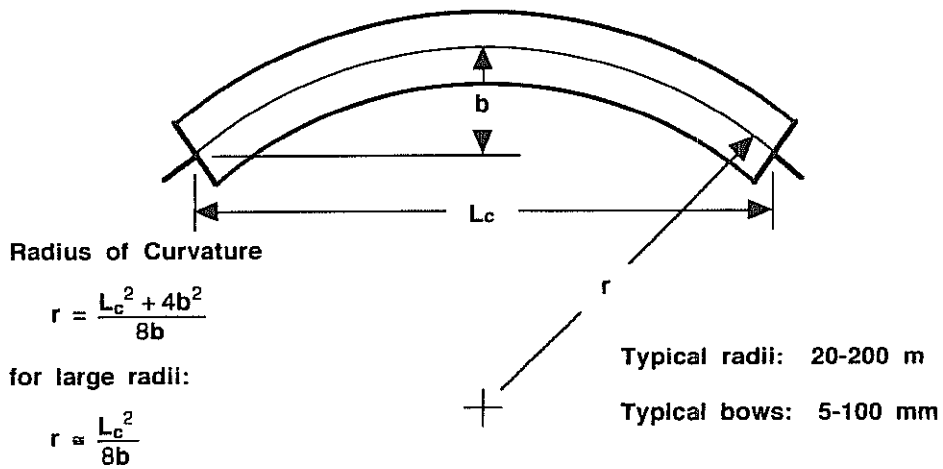
**Figure 8**  
**The Bowed Spreader Roller**

The bowed roller is a bearing supported cover on a curve stationary bar.

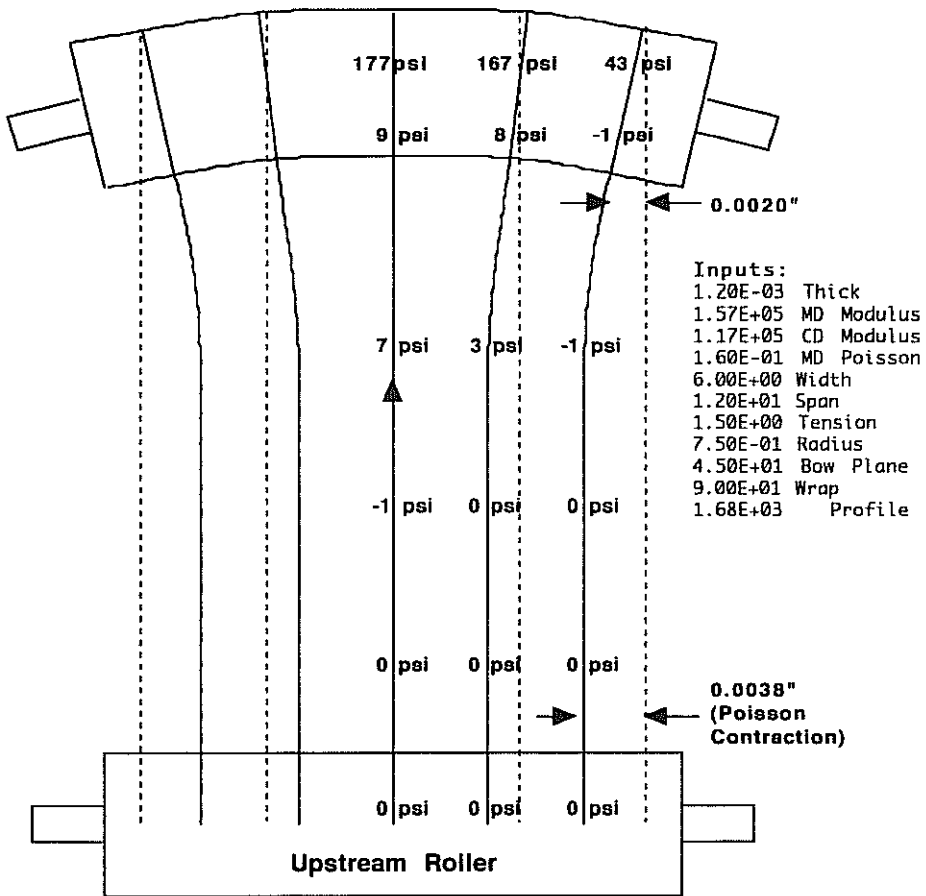


**Figure 9**  
**Bow Shape**

The axle of a bowed roller is usually bent into an arc of a circle.

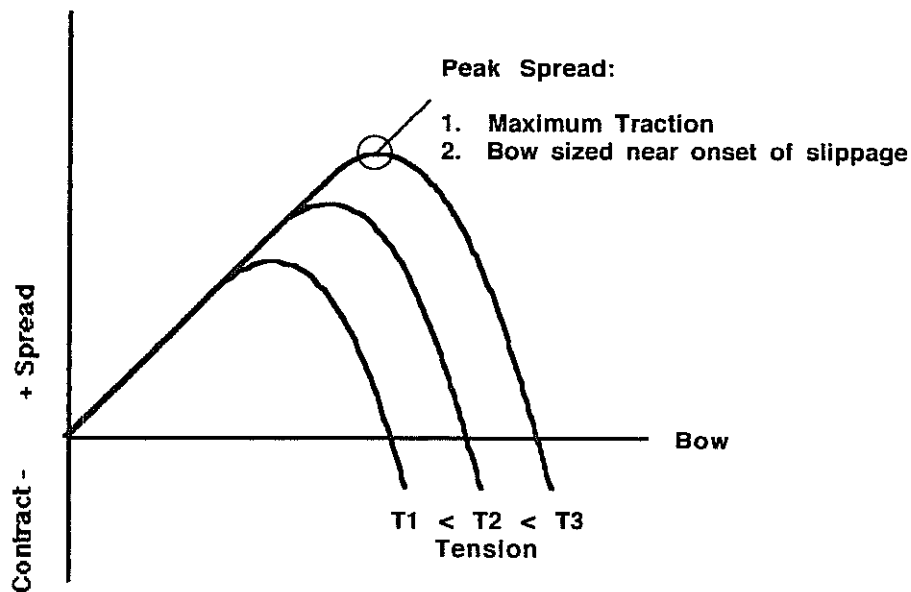


**Figure 10**  
**CD Web Stress/Strain in a Bowed Spreader Roller**  
 Data Courtesy Dr. Ronald Delahoussaye

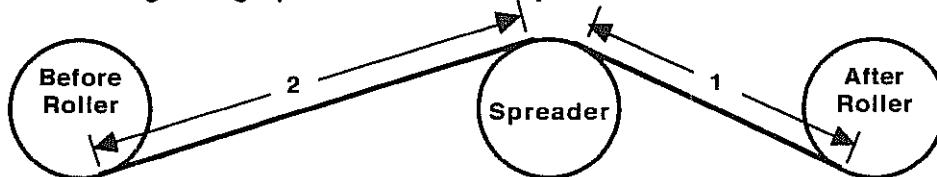




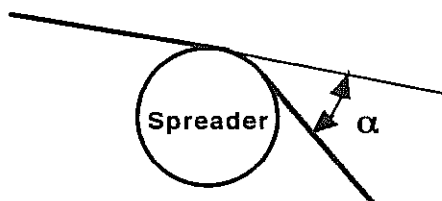
**Figure 11**  
**Effect of Bow & Traction on the Amount of Spread**  
 The optimum bow for maximum spread depends on tension and traction.



**Figure 12**  
**Entering/ Exiting Span Ratio**  
 The entering/exiting span ratio is desirably about 2:1.

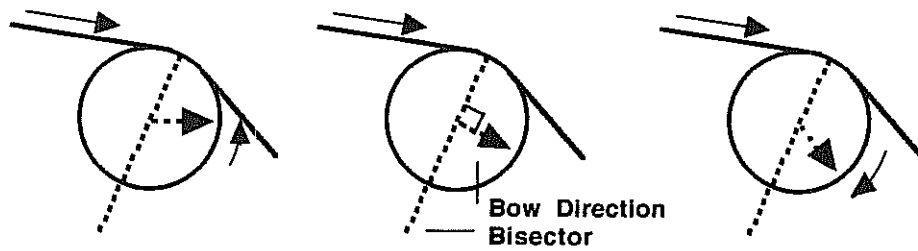


**Figure 13**  
**Spreader Roll Wrap Angle**  
 The bowed roller wrap angle is typically around 30°.



**Figure 14**  
**Bowed Spreader Roll Bow Orientation.**

The bow is pointed downstream on the perpendicular bisector of the wrap.



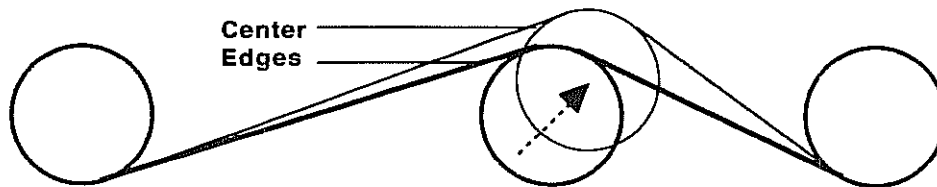
Rotate Bow INTO web  
to tighten  
slack CENTER

IDEAL BOW DIRECTION

Rotate Bow OUT OF web  
to tighten  
slack EDGES

**Figure 15**  
**Bow Orientation Changes Span Lengths**

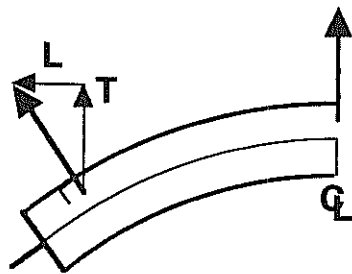
A bow turned into the sheet makes the center span length longer/tighter.



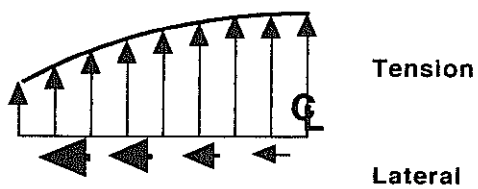
**Figure 16**  
**Stresses at a Bowed Roller**

Lateral and bending forces both contribute to move the web outward.

Velocity Vectors (left half)



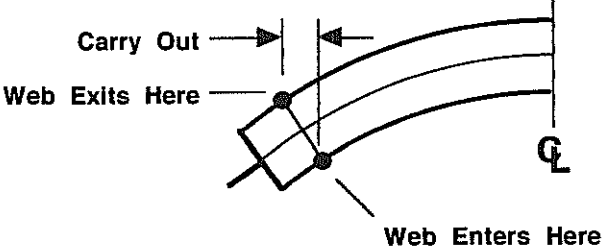
Tension & Lateral Distributions (left half)



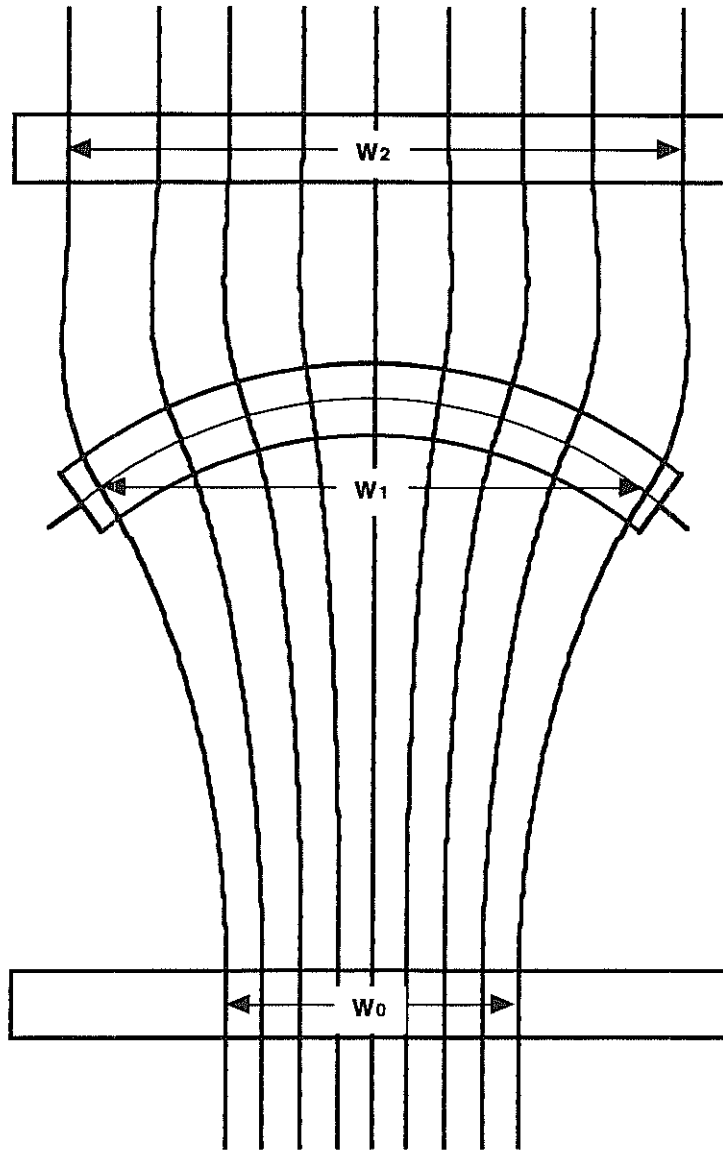
**Figure 17**

**Wrap Effects on Bowed Roller Spreading**

As the wrap increases, so does the carry outward effect. For 180° wrap:

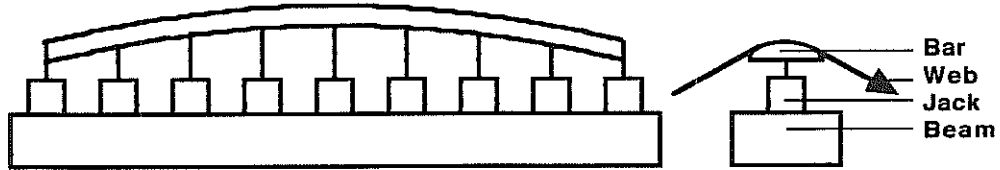


**Figure 18**  
**Bowed Roller Web Path**  
Web streamlines for various deckle positions.



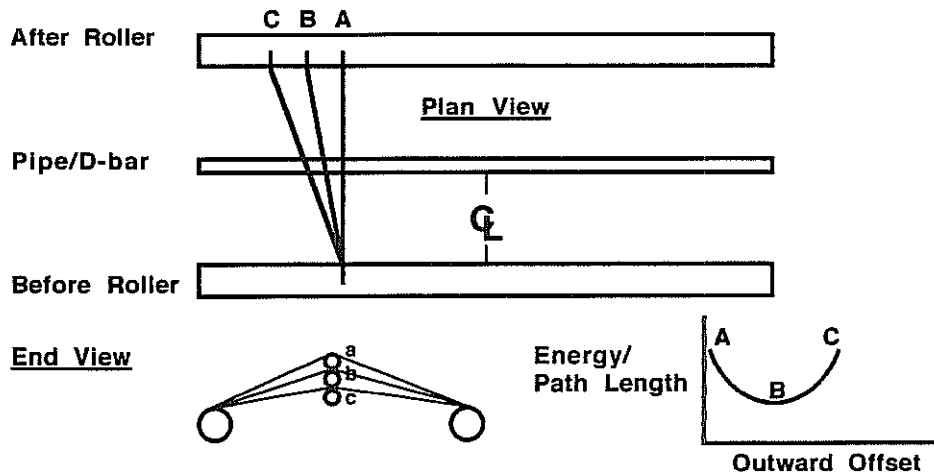
**Figure 19**  
**D-Bar Spreader**

A D-Bar spreader is a stationary bar with intermediate jack adjustments.



**Figure 20**  
**Pipe/D-Bar Mechanics**

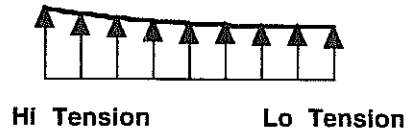
The web will seek a minimum energy path (length) through the spreader.



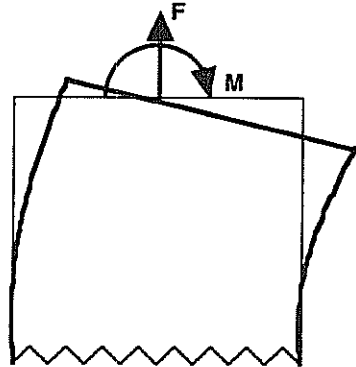
# Figure 21 Effect of Friction on Pipe/D-Bar Spreaders

The web is steered by bar/web friction.

## Tension/Friction Profile



## Induced Moment and Shape



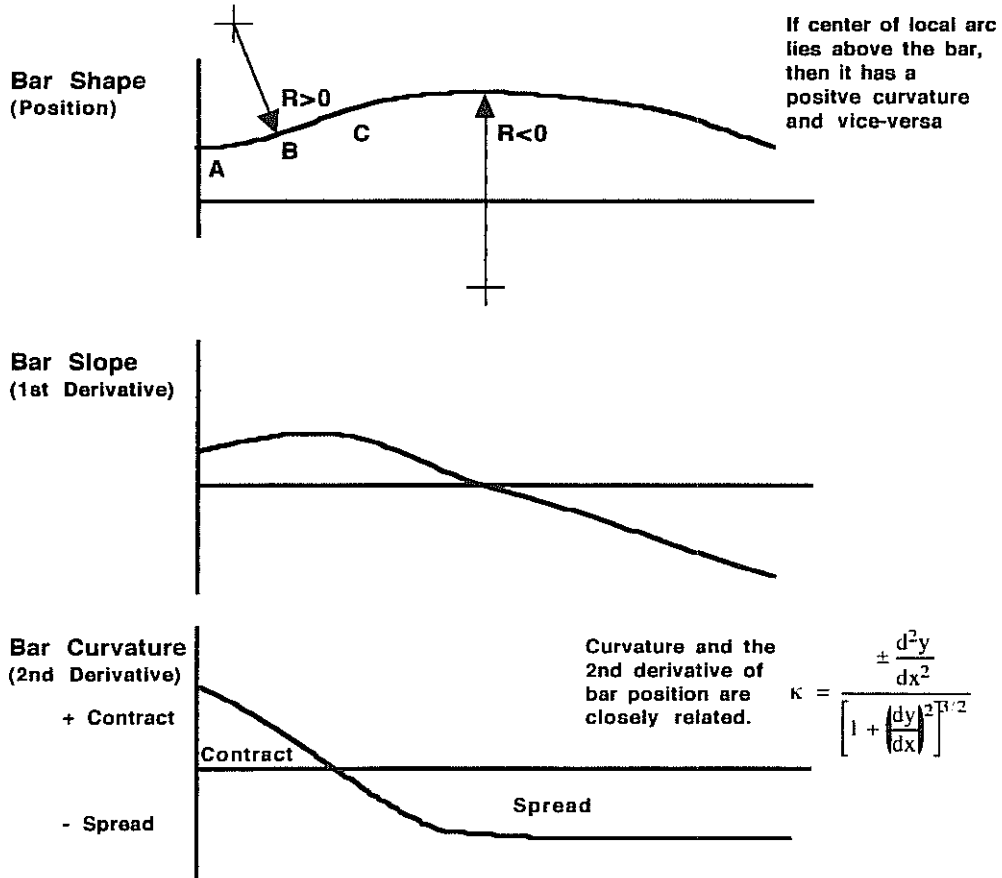
Note:

Remember, the Normal Entry Law applies only to non-slipping rollers.

Thus, the web does NOT have to enter a sliding pipe or D-b spreader normal to the local axis.

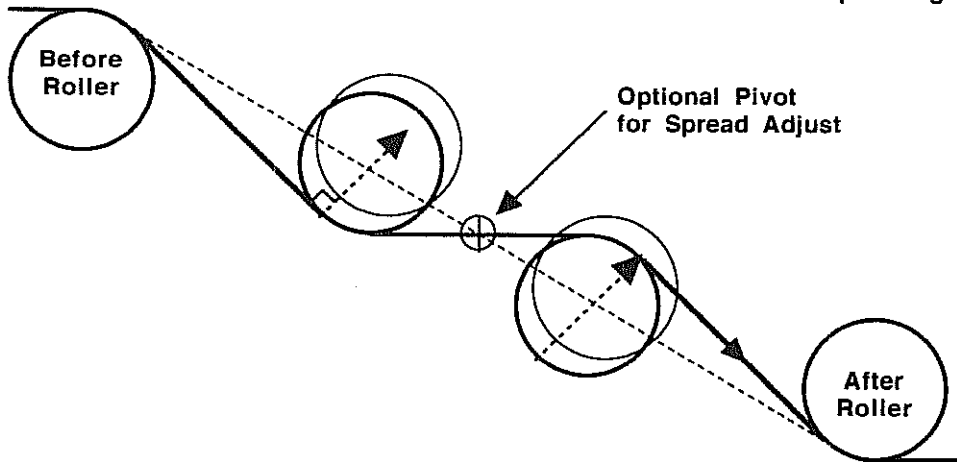
## Figure 22 A 'Snake' Shaped D-Bar

Web positions with a positive curvature may wrinkle or overlap slits.



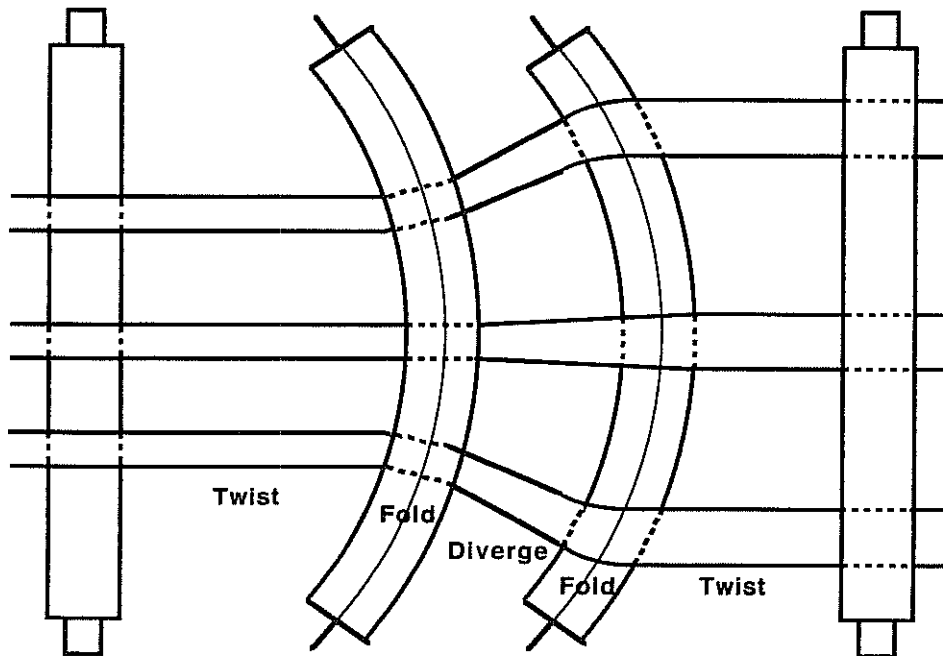
**Figure 23**  
**The Dual Bowed Roller Spreader**

The dual bowed roller has two fixed bowed rollers for twist/fold spreading.



**Figure 24**  
**The Dual Bowed Roller Mechanics**

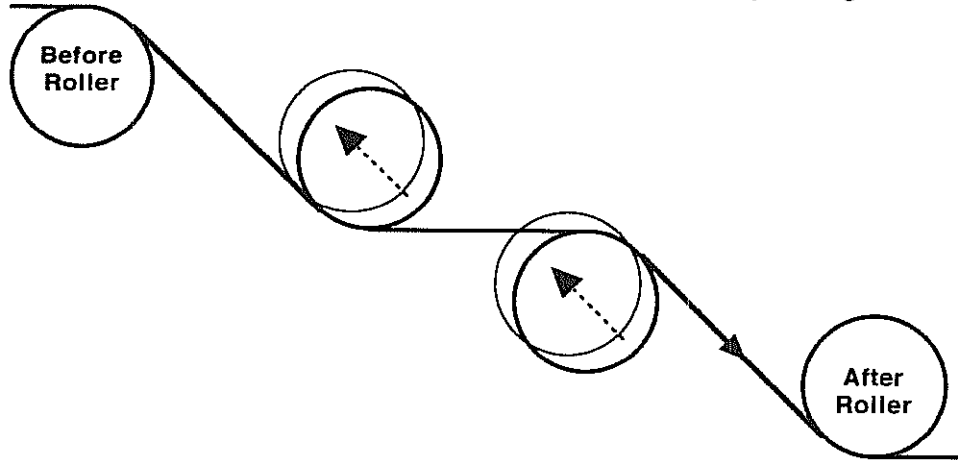
Though difficult to see in this view, all entries and exits are normal.





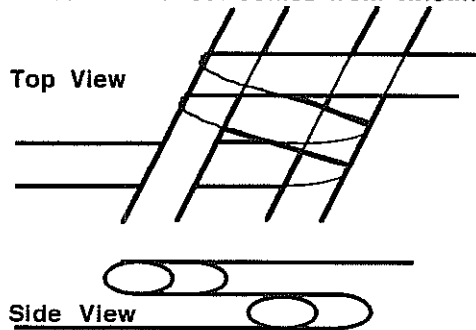
**Figure 25**  
**The Pos-Z™ Spreader**

The Pos-Z™ has two stationary bowed bars for twist/fold spreading.

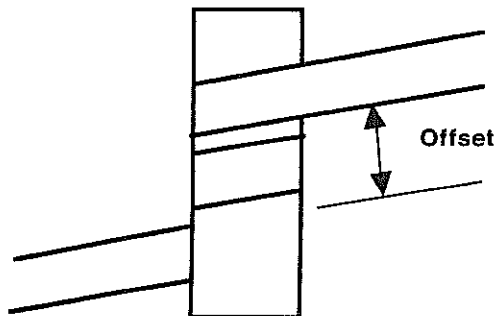


**Figure 26**  
**The Pos-Z™ Spreader Mechanics**

The outward offset comes from twisting/folding, normal entry not enforced.

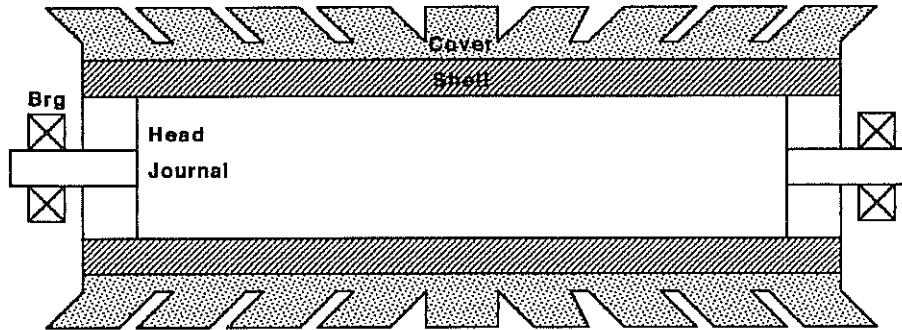


A simple demonstration of the offset capability of a pair of angled Pos-Z bars can be demonstrated as shown at left using a strip of paper and two pencils.



The Pos-Z spreader provides web offset because it wraps the bar at a tiny helix angle such as exaggerated here. Twisting and folding is simultaneous at the bars, but the open spans see no additional strains.

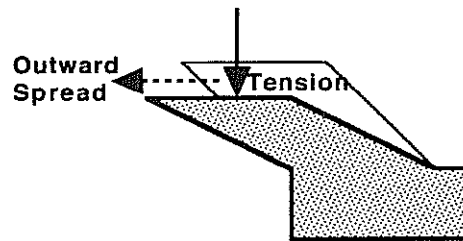
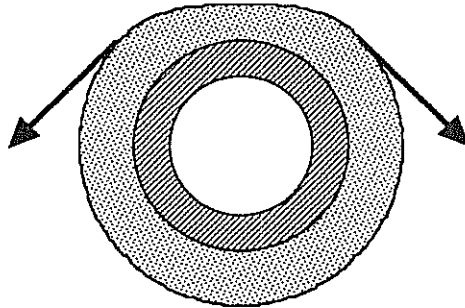
**Figure 27**  
**Compliant Cover Spreader**  
 Has a very soft cover with special undercut grooving.



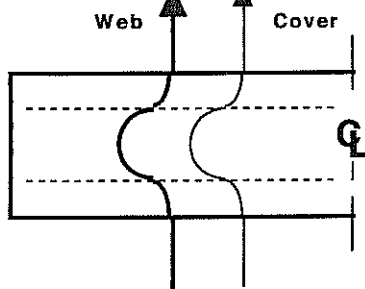
**Figure 28**  
**Compliant Cover Spreader Principle**  
 The cover defects outward as it passes over the roller.

Cover Deflection - End View

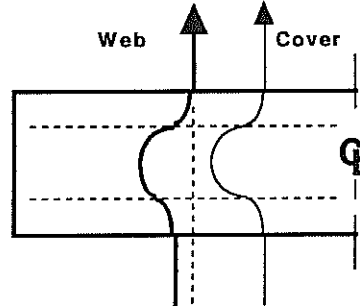
Land Deflection - Side View



Web/Cover Paths - Traction  
 Plan View, Left Side  
 No Spread?

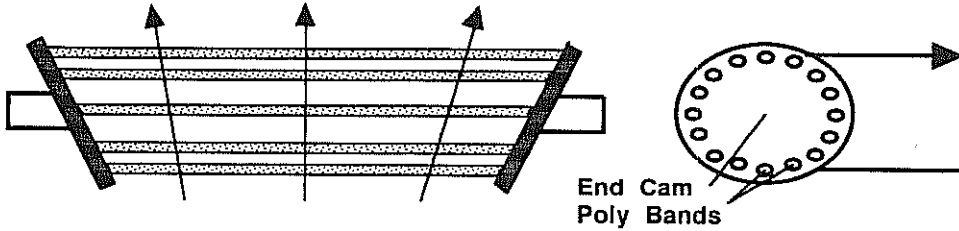


Web/Cover Paths - Slippage  
 Plan View, Left Side  
 Contraction



**Figure 29**  
**Slatted Spreader Roller**

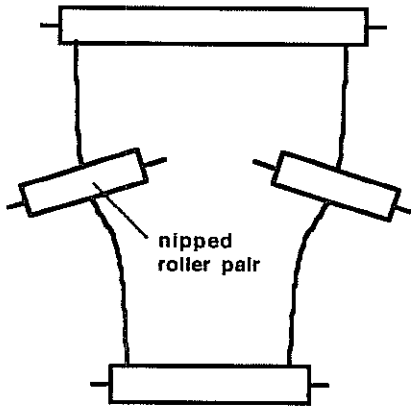
Has cam actuated 'rubber bands' as a cover which expands.



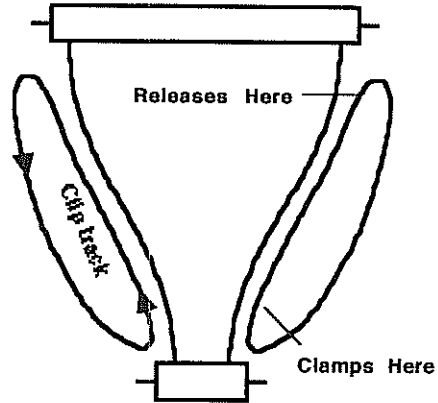
**Figure 30**  
**Edge Pull Web Stretchers**

Grip and pull the edges of the web outward.

Web Stretcher Rollers



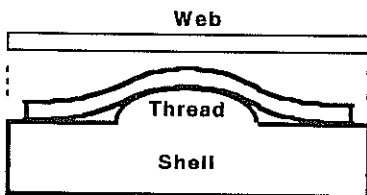
Tenter



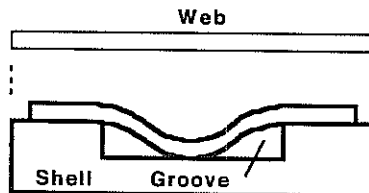
**Figure 31**  
**Contraction by Raised Threads and Grooves**

Caused by the increasing CD arc length along the surface.

Raised Thread Rollers  
 (aka worm rolls)



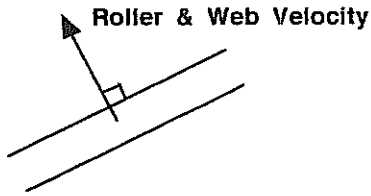
Wide Grooved Rollers



### Figure 32 Force Vectors over Rollers and Spreaders

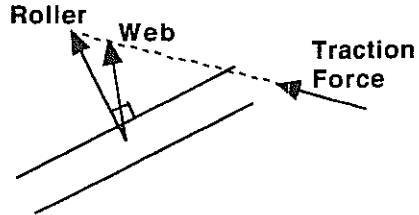
For a tractive bowed roller, a slipping bowed roller, and a slipping bar.

Fully Tractive Bowed Roller



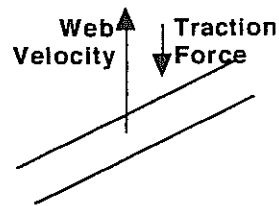
Known: Roller Velocity  
Web Velocity  
Unknown: Spread  
Traction Forces  
Web Stresses

Slipping Bowed Roller



Known: Roller Velocity  
Unknown: Web Velocity  
Spread  
Traction Forces  
Web Stresses

Stationary Bar

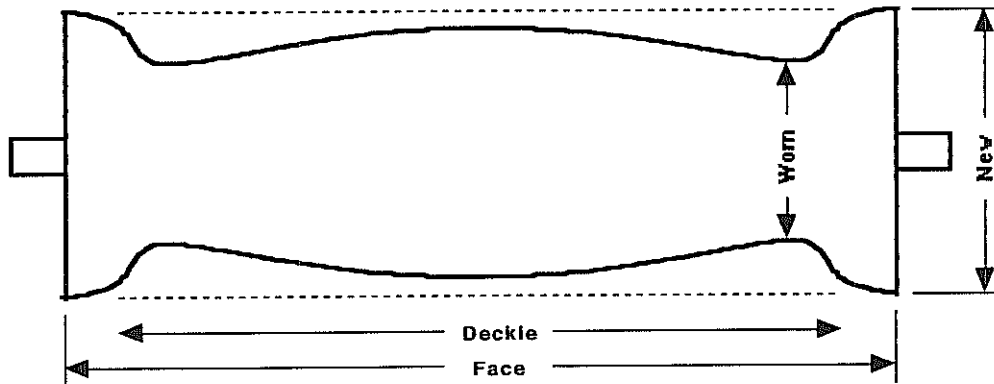


Known: Roller Velocity  
Web Velocity  
Traction Forces

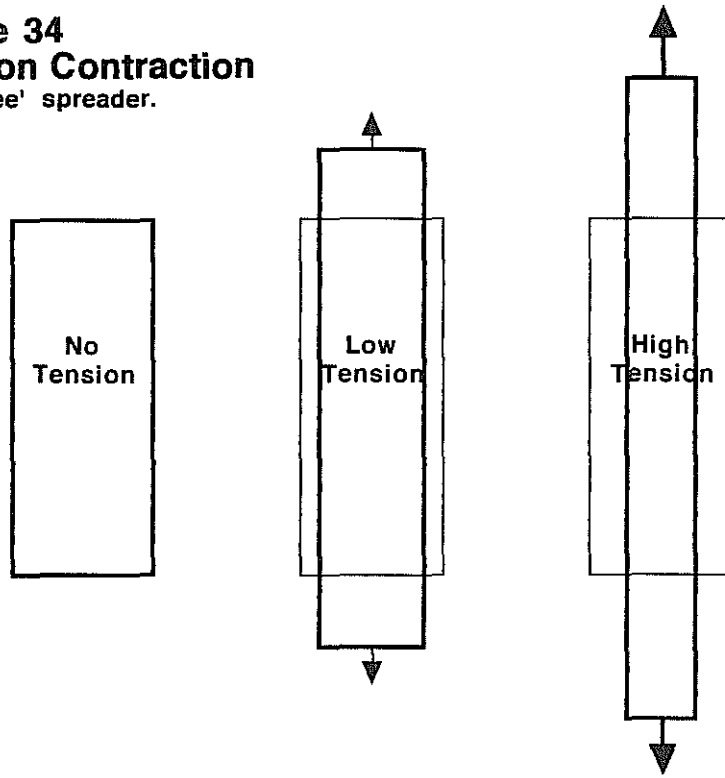
May be Known: Spread  
Web Stresses

### Figure 33 Typical Slippage Induced Spreader Wear

Is maximum near the edges of the web.



**Figure 34**  
**Poisson Contraction**  
The 'Free' spreader.

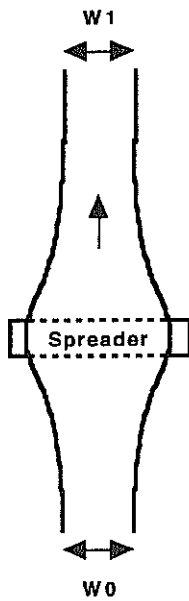


## Figure 35 Spreading is Temporary

Spreading dissipates due to necking, weave, and camber.

### Necking

The web will return to its 'natural' width in about 1 width downstream.



### Weave

Random disturbances which are different for each deckle position steadily moves some deckle positions apart, and others together.



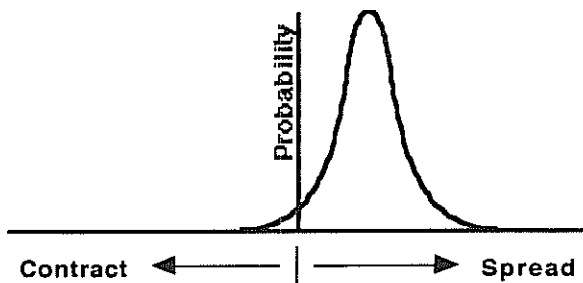
### Camber

The web has a natural curvature which moves some deckle positions apart, and others together.

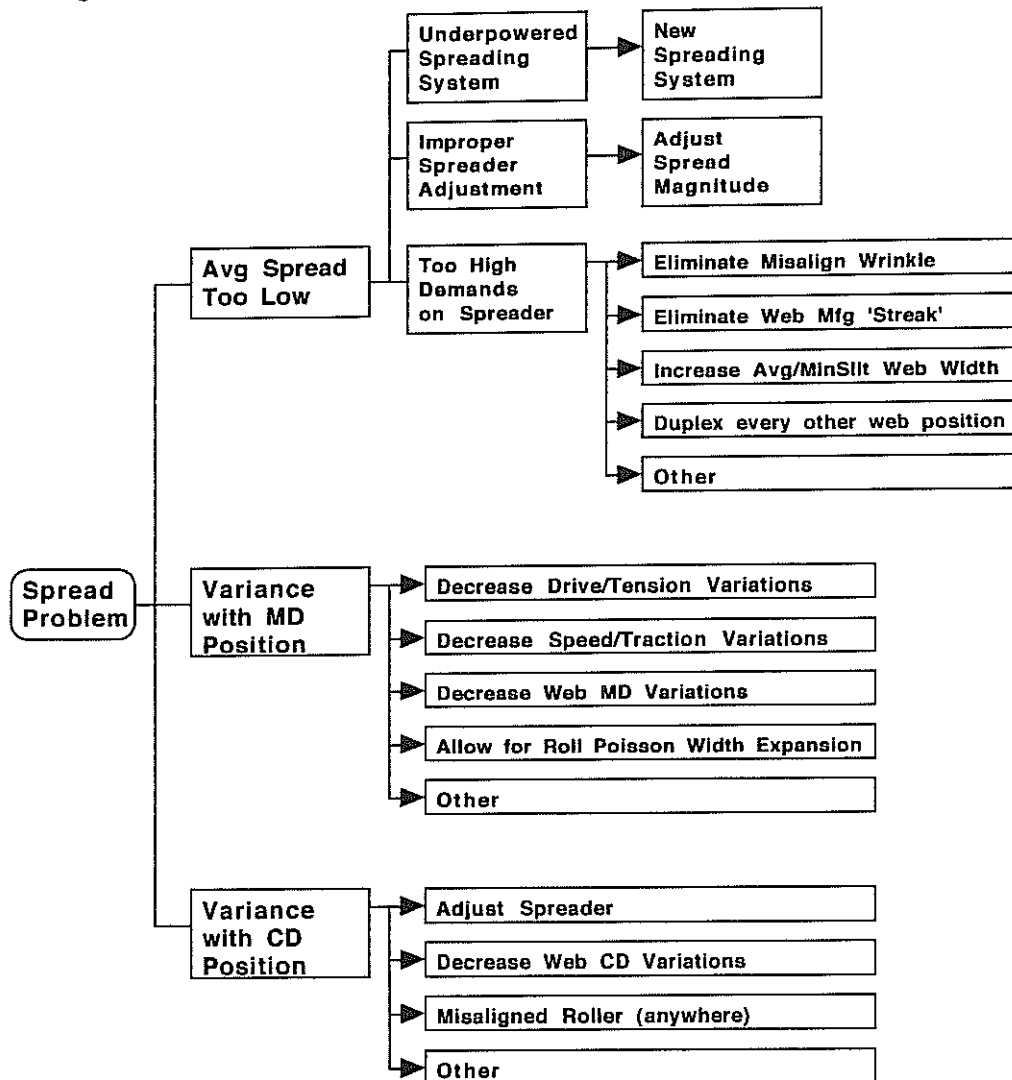


## Figure 36 Spread Distribution

While we can adjust *average* spread, *minimum* spread is what is important.



**Figure 37**  
**Spreading Problem Diagnostics**  
 Using Fault Tree Analysis.



**QUESTIONS AND ANSWERS**

- Q. How can you tell if a spreader roller is in traction?
- A. One simple way is to apply machinist's bluing to a roller. After a couple of hours of running, one may see the bluing worn off in areas where the web was sliding. This also works well as a check if air floatation bars are truly floating across the entire width. Rollers or bars may be floating, sliding, or in traction,

all of which could be acceptable. However, what can be a problem is if there are mixed modes, such as partially floating.

- Q. Isn't the concave roller symmetric in operation?
- A. While the speed profile is symmetric upstream vs. downstream, the tension profile is anti symmetric.
- Q. How does the normal entry rule apply to the concave spreader?
- A. The web enters normal to the axis of the roller, not the surface.
- Q. Is the second derivative of shape a necessary quality control target for a bowed roller?
- A. It depends on the application. On narrow or unslit webs, any approximate shape may do. However, on wide webs with many slits, it is important to have the slit separation uniform and consistent to reduce would roll tie ups.