

A STUDY OF HYDROCYCLONE SEPARATION
IN WATER CLARIFICATION

By

THOMAS JAMES COBB

Bachelor of Science

Oklahoma State University

Stillwater, Oklahoma

1970

Submitted to the Faculty of the Graduate College
of the Oklahoma State University
in partial fulfillment of the requirements
for the Degree of
MASTER OF SCIENCE
May, 1971

OKLAHOMA
STATE UNIVERSITY
LIBRARY
AUG 11 1971

A STUDY OF HYDROCYCLONE SEPARATION
IN WATER CLARIFICATION

Don F Kincannon
Thesis Adviser

W. L. Liederman, Jr.

H. P. Guedy, Jr.

D. D. Sullivan
Dean of the Graduate College

788217

ACKNOWLEDGMENTS

The author would like to take this opportunity to express his sincere appreciation to the many people who had such a large part in making this course of study possible.

To Dr. Don Kincannon whose great amount of encouragement and assistance was felt even before I entered graduate school and he became my principal adviser.

To Dr. W. G. Tiederman for his excellent suggestions and advice during the course of study and his careful reading of the manuscript.

To Dr. Anthony Gaudy whose careful reading and critique of the manuscript was greatly appreciated.

To Mrs. Peggy Smith for accurately typing this manuscript.

To my parents whose pride has been a great source of incentive for me.

Most important, to my wife, Linda, who always managed to raise my spirits throughout the difficult periods.

Lastly, to the Federal Water Pollution Control Administration which made this work possible through the bioengineering training grant 1T1-WP-238-01.

TABLE OF CONTENTS

Chapter	Page
I. INTRODUCTION	1
II. LITERATURE RESEARCH	3
Gravity Sedimentation	3
Tube Clarification Process	4
Hydrocyclone Applications	7
III. MATERIALS AND METHODS	9
Hydrocyclones	9
Clays	14
Analytical Procedures	15
Experimental Procedures	16
IV. EXPERIMENTAL RESULTS	20
General	20
Single-Pass Studies	21
Continuous Recycle Studies Without Trap	44
Continuous Recycle Studies With Trap	45
Effects of Coagulant Agents	53
V. DISCUSSION	55
VI. CONCLUSIONS	60
VII. SUGGESTIONS FOR FUTURE STUDY	61
SELECTED BIBLIOGRAPHY	62
APPENDIX	64

LIST OF TABLES

Table	Page
I. Critical Flow Dimensions of the Hydrocyclone Configurations.	13
II. Size Distribution of PRC and RMGC	14
III. Removal Rates	47
IV. Removal Rates	50
V. Optimum Coagulant Dosages	54

LIST OF FIGURES

Figure	Page
1. Open Underflow Hydrocyclone.	10
2. Closed Pot Hydrocyclone.	11
3. Closed Pot Hydrocyclone with Contamination Trap, (Patent Rights Assigned to Oklahoma State University).	12
4. Pump Calibration Curves.	17
5. Flow Loop for Single-Pass Studies.	18
6. Flow Loop for Continuous Recycle Studies	18
7. Single-Pass Results, Hydrocyclone #1, PRC with Coagulation	22
8. Single-Pass Results, Hydrocyclone #1, RMGC with Coagulation	23
9. Single-Pass Results, Hydrocyclone #1, Kaolinite with Coagulation	24
10. Hydrocyclone #1, Concentration Efficiency with Coagulation, (U = Solids Concentration in Underflow, I = Solids Concentration in Inlet Flow)	26
11. Hydrocyclone #1, Separation Efficiency with Coagulation, (E = Solids Concentration in Overflow Effluent, I = Solids Concentration in Inlet Flow)	27
12. Single-Pass Results, Hydrocyclone #1, PRC without Coagulation.	28
13. Single-Pass Results, Hydrocyclone #1, RMGC without Coagulation	29
14. Single-Pass Results, Hydrocyclone #1, Kaolinite without Coagulation.	30

Figure	Page
15. Hydrocyclone #1, Concentration Efficiency without Coagulation, (U = Solids Concentration in Underflow, I = Solids Concentration in Inlet Flow)	32
16. Hydrocyclone #1, Separation Efficiency without Coagulation, (E = Solids Concentration in Overflow Effluent, I = Solids Concentration in Inlet Feed)	33
17. Single-Pass Results, Hydrocyclone #2, PRC without Coagulation	35
18. Single-Pass Results, Hydrocyclone #2, RMGC without Coagulation.	36
19. Single-Pass Results, Hydrocyclone #2, Kaolinite without Coagulation	37
20. Hydrocyclone #2, Concentration Efficiency without Coagulation, (U = Solids Concentration in Underflow, I = Solids Concentration in Inlet Feed)	38
21. Hydrocyclone #2, Separation Efficiency without Coagulation, (E = Solids Concentration in Overflow Effluent, I = Solids Concentration in Inlet Feed)	39
22. Single-Pass Cumulative Removal Efficiency for PRC	41
23. Single-Pass Cumulative Removal Efficiency for RMGC.	42
24. Single-Pass Cumulative Removal Efficiency for Kaolinite	43
25. Continuous Recycle Results, Removal of Turbidity with Closed Pot	45
26. Continuous Recycle Results, Removal of Solids with Closed Pot.	46
27. Continuous Recycle Results, Removal of Kaolinite Turbidity using Coagulation	48
28. Continuous Recycle Results, Removal of Kaolinite Turbidity without Coagulation	49

Figure	Page
29. Continuous Recycle Results, Removal of Turbidity Using Closed Pot with Contamination Trap.	51
30. Continuous Recycle Results, Removal of Solids Using Closed Pot with Contamination Trap	52
31. Effect of Flow Rate on the Separation Efficiency of the Hydrocyclone with Contamination Trap, (AC Fine Test Dust).	57

CHAPTER I

INTRODUCTION

The separation of solids from liquids is one of the most important unit operations in water and wastewater treatment. The most widely used method for this separation is gravity sedimentation. Investment in sedimentation tanks represents a significant portion of the total cost of water and wastewater treatment plants. The process itself is time consuming and has many inherent problems. In spite of this, the basic design criteria for sedimentation facilities has undergone little change in the last forty years.

As population increases, the need for potable water also increases. Less costly methods of treating water must be found. The capacity of existing facilities needs to be increased.

Advances are being made. The recent development of "tube settlers" has increased the clarification capacity of many treatment plants. However, many of the problems related to conventional settling tanks are still present. Many other techniques of separation have been tried with varying degrees of efficiency. Yet, gravity settling remains the most economical, although not the most efficient.

The hydrocyclone has found widespread acceptance in industry for solids-liquid separation. Its advantages include low cost, high efficiency and small size. The size of the hydrocyclone makes possible the development of compact, portable water treatment systems.

The purpose of this investigation was to determine the feasibility of using the hydrocyclone as a clarifier of water which contains inorganic colloidal particles. An existing hydrocyclone was used to study the effects of various parameters on hydrocyclone performance. These parameters included clay particle size, varied flow rates and different hydrocyclone configurations. Three clays of varied size ranges were investigated and the hydrocyclone was studied in three configurations. The hydrocyclone performance was determined by turbidity and by solids measurements.

At the completion of the studies with the existing hydrocyclone, a second hydrocyclone was obtained with a smaller design. Some studies were made with this hydrocyclone to indicate the direction which new designs should take to improve hydrocyclone performance.

CHAPTER II

LITERATURE RESEARCH

Gravity Sedimentation

Gravity sedimentation is a slow, costly process of separating solids from liquids. Yet it is the most widely used method for this purpose in water and wastewater treatment facilities. The extensive use of gravity settling is probably due to the fact that no other separation techniques have been able to compete with it on an economic basis. A review of the literature will reveal many of the problems of gravity separation. Some of these problems are reviewed here to show that problems do exist and to determine their nature.

One major problem found in raw water clarification is caused by the characteristics of the metal hydroxide floc. In a discussion on water treatment, Aitken (1) stated the most difficult solid matter to deal with is the fleecy-like floc consisting of metallic hydroxides produced by chemical treatment of water in order to adsorb matter which is initially present in colloidal forms.

Another problem that plagues settling basins is undesirable hydraulic phenomena. Hirsch (2) enumerated these phenomena as follows:

- (1) poor distribution at the inlet
- (2) jetting at the inlet
- (3) eddy currents
- (4) short circuits
- (5) density currents
- (6) wind currents

- (7) terminal uplift
- (8) terminal efflonetry (chimney updraft)

Hirsch went on to say the basic defect in settling basin design is universal updraft of suspended particles and floc at the effluent end of tanks, which is prevented by costly operation at a slow rate or by lavishly overdosing with coagulant.

Tekippe and Cleasby (3) suggested that temperature changes play an important role in the hydraulic stability of settling basins. They cited a circular center-feed study which showed that a temperature gradient of 0.5° F above tank temperature to 1.5° F below tank temperature can affect tank efficiency. Mărută (4) also indicated that temperature gradient is a major disturbance of the sedimentation process, along with small Froude numbers and high concentrations of fine suspended material.

Fuller (5) discussed the problem of sludge removal from the basin floor. Even with an adequate sludge bed, slow continuous withdrawal from any one area will eventually create channeling and result in the thinner supernatant being withdrawn through the pipes.

Tube Clarification Process

In light of the problems of gravity settling, much work has been done to develop new methods of solids-liquid separation. Many of these methods are less time consuming and more efficient than conventional sedimentation but are not economically feasible. Recently, however, a process utilizing shallow depth settling theory called the "Tube Clarification Process" has found relative success in water and wastewater treatment for solids-liquid separation. The method is based on the concept that a settling basin should be as shallow as possible,

and as consequence detention times could be short. The theory of this process and a complete description of its operation are discussed in the literature (6), (7) and (8).

The advantages of tube settling are discussed here in order to show that significant advances are being made on gravity settling. The disadvantages are also discussed to show the need for further development of new methods of solids-liquid separation.

H. G. Dresser (9) described an early attempt to increase the capacity of an existing settling basin utilizing shallow depth settling theory. Two horizontal trays were added to the basin. The detention time stayed about the same but the overflow rate was cut from 1850 to 690 gpd/ft². This was nearly a three-fold increase in settling capacity. However, the tanks needed to be drained and flushed every ten days.

The tube settling process allows the long recognized advantages of shallow depth sedimentation to be applied in a practical manner. Culp and Conley (8) stated the tube-clarifier concept permits marked reductions in size and cost of water of wastewater clarification facilities and is in use in over 50 such plants ranging in size from 10 gpm to 45 MGD (imperial gallons).

Culp and others (6) suggested that due to the shallow depth of the tubes (generally 2 inches) the total detention time of the tube chamber may be less than ten minutes while still providing efficient clarification. This permits compact systems to be developed. Also, in some cases, the coagulation and flocculation steps may not be needed.

The tube settlers are followed by mixed media filters. Hansen and Culp (7) stated that detention times of 6 minutes and less are

adequate for sedimentation when using the shallow depth tubes in combination with the mixed media filter. The potential cost and space savings over settling basins with 1-4 hour retention are obvious.

One major advantage of this process cited by Culp and Conley (8) is positive, "automatic" sludge withdrawal each time the filter back-washes. This eliminates operator judgment on the frequency and quantity of sludge blowdown from the clarifier--a particular advantage in small plants.

Culp and others (6) discussed an actual application of the tube settlers. Regina, Saskatchewan required higher raw water clarification capacity. For a six-month test period, a tube installation was operated at over 2-1/2 times the design rate of the parallel conventional units, while producing an average effluent turbidity of 0.5 units. The frequency of cleaning varied from once in two months to once a week.

There are limitations to the tube clarification process. Culp and Conley (8) stated that size limitation results from the hydraulic problems associated with the rapid draining of the tubes, which becomes increasingly difficult with increasing plant capacity. Also, the technique of tube cleaning and refilling requires a downstream filter.

Dick (10) suggested that the installation of tubes may increase clarification capacity, but at the same time they increase the sludge loading. This may be detrimental when sludge loading is high and this in itself may even limit the operation. The sludge is not able to be thickened, thus diluted sludge is drawn from the tank.

Hydrocyclone Applications

Because of its simplicity of design and operation, the hydrocyclone, which has found widespread application in industry, has considerable potential as a clarifier in water treatment. In many cases, a clarification system for water treatment necessitates the removal of colloidal particles. Some work has already been done applying the hydrocyclone to the removal of colloids. Some of this work is reviewed here to show the applicability of the hydrocyclone to small particle separation.

Haas and others (11) discussed a hydrocyclone developed to remove precipitated fission and corrosion products from uranyl sulfate solutions in aqueous homogeneous reactions. They found they could attain acceptable separation of particles approximately 1μ in diameter.

Tangel and Brison (12) stated the hydrocyclone could make separations as coarse as 100 mesh or as fine as 2μ in some special cases. They went on to mention other applications, including classifying bentonite and pumice slurries at 10μ .

Daughty (13) suggested that if the solids are coarse (greater than 50μ) as is often the case when water is extracted from a river, a cyclone is a satisfactory and very cheap method of obtaining crystal clear water. Daughty also cited separation of fine clay (less than 5μ) from coarse clay.

Some work has been done directly applying the hydrocyclone to water treatment. Barskii (14) reported progress in this area. He discussed the advantages of hydrocyclones over sedimentation tanks for the treatment of water and trade wastewaters. These advantages include reduced cost, smaller space requirements, and easier removal of sludge.

The cost was reduced 6 to 10 times and the hydrocyclone system occupied 100 times less space. Barskii reported removal of clay particles with grain size greater than $2-5\mu$.

Water Engineering Ltd. recently started producing the patented Daynor Hydrocyclone. Molyneux (15) stated that the Daynor Hydrocyclone followed by a pressure sand filter has found particularly extensive use in England during the past few years. Water Engineering Ltd. guarantees the Daynor to effect complete removal of all particles of size greater than 60μ and with a gravity greater than 1.4.

CHAPTER III

MATERIALS AND METHODS

Hydrocyclones

Two hydrocyclones were used in the investigation. The first, Hydrocyclone #1, was an existing model and its performance was studied in three different configurations. The open underflow configuration is shown in Figure 1. The flow enters the inlet feed and exits through the overflow outlet and the underflow outlet. Frequently there are situations where it is either awkward or impossible to have both the underflow outlet stream and the overflow outlet stream. In these cases, a collection pot can be placed below the underflow diameter and the separated solids can be held and stored in this collection pot. The resulting configuration is the closed pot configuration which is shown in Figure 2. The third configuration is formed when a contamination trap is added in the collection pot. A closed pot hydrocyclone with a contamination trap is shown in Figure 3. The contamination trap used a Marvel Engineering Company filter element which has a nominal rating of 4 microns.

The underflow diameter of Hydrocyclone #1 had to be large enough to accommodate the return flow tube of the contamination trap. However, due to this large underflow diameter, the resulting quantity of underflow in the open underflow configuration was much too large. This problem was solved by inserting a plug to reduce the underflow diameter.

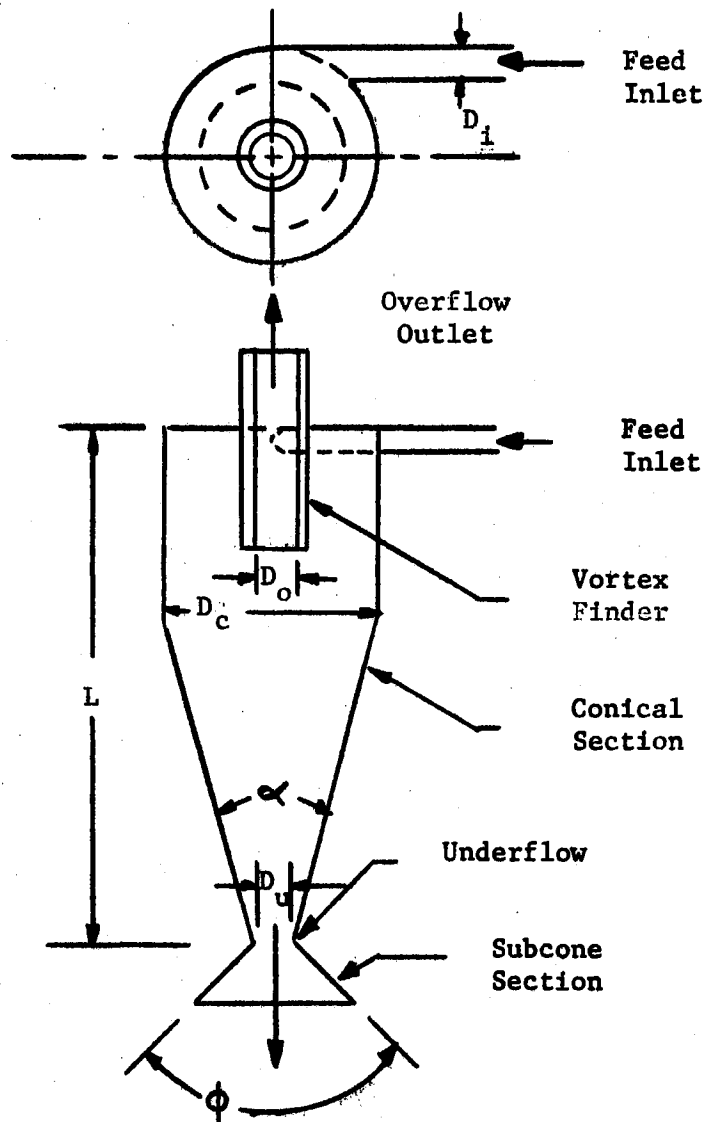

Figure 1. Open Underflow Hydrocyclone

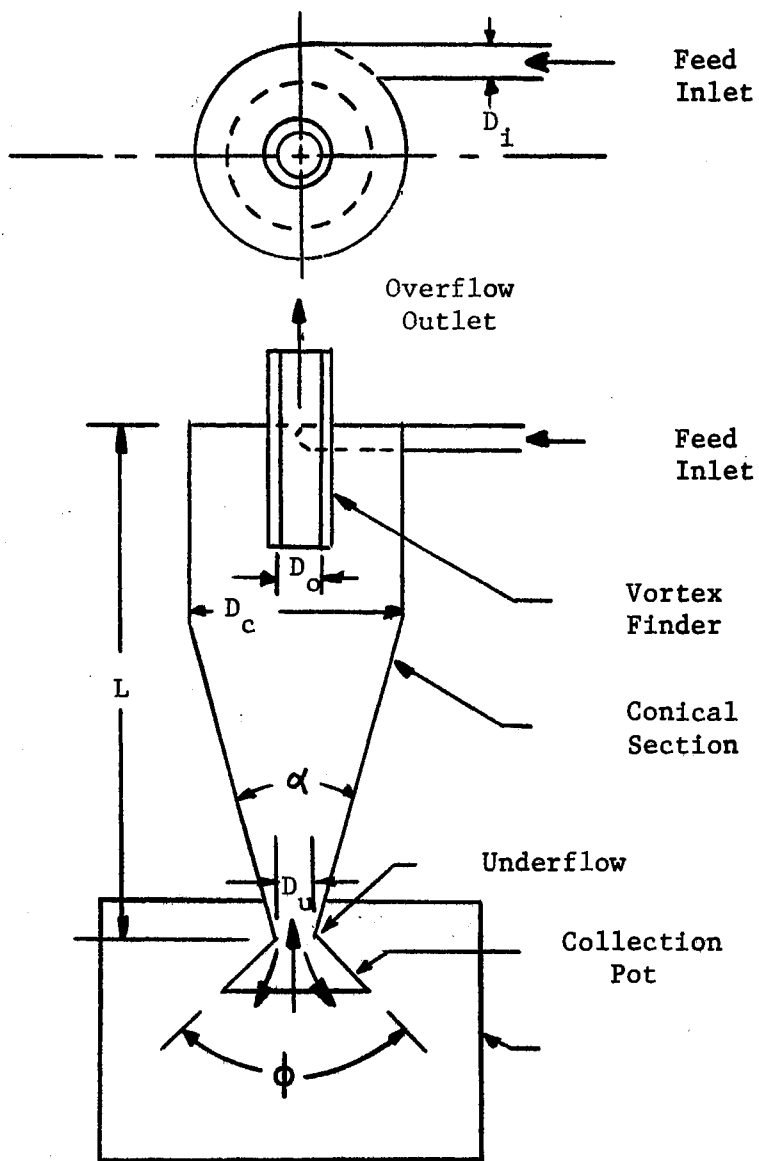

Figure 2. Closed Pot Hydrocyclone

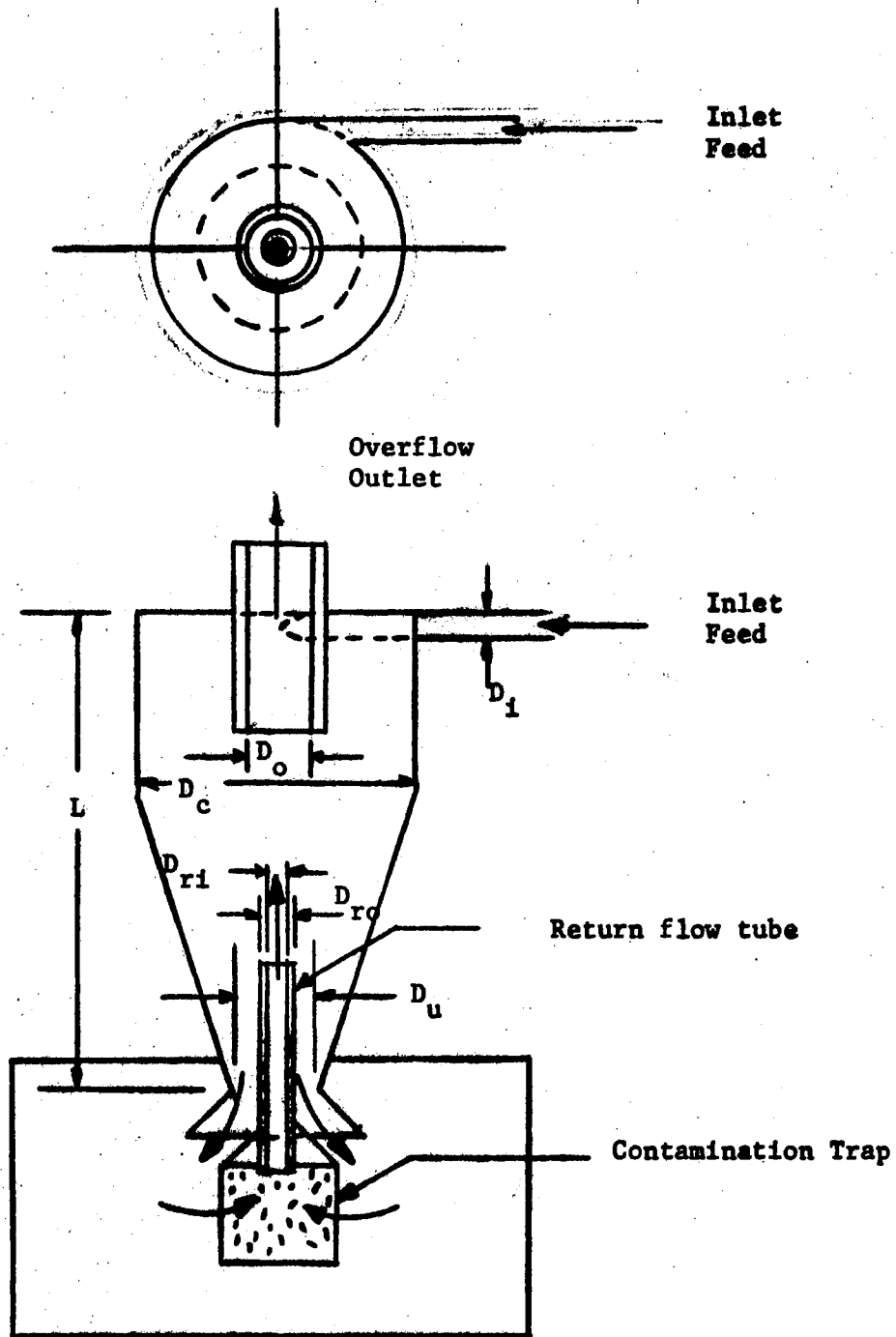

Figure 3. Closed Pot Hydrocyclone with Contamination Trap, (Patent Rights Assigned to Oklahoma State University. (16))

This insert was used during those studies in which the contamination trap was not in use.

Hydrocyclone #2, which was the smaller of the two, was studied only in the open underflow configuration. This model was designed to remove smaller particles than the other model. Table I presents the critical flow dimension of the hydrocyclones for each configuration in which they were studied.

TABLE I
CRITICAL FLOW DIMENSIONS OF THE
HYDROCYCLONE CONFIGURATIONS

Parameter	#1 Open Underflow	#1 Closed Pot	#1 Closed Pot With Trap	#2 Open Underflow
D_c	2.46	2.46	2.46	1.00
D_i	0.215	0.215	0.215	0.119
D_o	0.375	0.375	0.375	0.138
D_u	0.172	0.172	0.308	0.061
α	20°	20°	20°	20°
ϕ	34°	34°	34°	--
L	11.720	11.720	11.150	6.00
D_{Ri}	--	--	0.153	--
D_{Ro}	--	--	0.216	--
L_R	--	--	1.50	--

Values are given in inches, (α and ϕ in degrees).

Clays

Three different clays were used--Kaolinite, Permian Red Clay (PRC), and Roger Mills Gray Clay (RMGC). These materials were selected because they represent a wide range of particle sizes.

The first, Kaolinite, is the only one of the three that is classified as a true clay mineral. Kaolinite is a naturally occurring two-layer aluminosilicate whose composition, crystallographic structure, and physical properties are well defined. Michaels and Morelos (17) gave a very detailed discussion on the physical properties of this clay mineral.

The Kaolinite is white in color and its particle size ranges from 0.5 to 2 microns. Clay minerals are classified as hydrophobic (water-hating) colloids. The particles are electrically charged and tend to stay in a dispersed state for long periods of time.

The PRC is a material of medium plasticity, obtained from the Permian deposits of Oklahoma. These marine deposits are the dominant geological formation of central Oklahoma. It has a distinctive red color due to its high iron oxide content. Its size distribution is given in Table II.

TABLE II
SIZE DISTRIBUTION OF PRC AND RMGC

	PRC	RMGC
Less than 10 μ	38.0%	82.0%
Less than 5 μ	32.0%	73.0%
Less than 1 μ	26.0%	2.0%

Table based on information from reference number 18.

The RMGC is a highly plastic clay obtained from Roger Mills County, in western Oklahoma. It has a distinctive steel gray color, resulting from the absence of high percentages of iron oxides. Its size distribution is also given in Table II.

All of the studies were made using a clay slurry of 100 mg/l. This was achieved by adding 3.8 grams of clay to 10 gallons of tap water. The 3.8 grams of clay was initially mixed as a concentrated slurry in an Osterizer blender at speed seven to insure complete dispersion.

Analytical Procedures

1. Coagulation Chemicals

Two coagulating chemicals were used in the study. They were aluminum sulfate (alum) and an organic polyelectrolyte. The polyelectrolyte is an organic, high molecular weight, cationic polyelectrolyte which is soluble in water. It has been identified as a polyalkaline polyamine. It is manufactured by Dow Chemical Company under the name Purifloc C-31. In each case, the optimum chemical dosage needed for flocculation was determined by the jar test studies which are described in the next paragraph.

2. Jar Studies

The jar studies were run with a Phipps and Bird, Inc., laboratory stirrer. The coagulants were prepared in a solution such that one ml contained five mg of coagulant. Six 500 ml samples were placed on the stirring apparatus. The desired amount of coagulant was added to each sample and quick mixed for one minute at 100 rpm. The samples were then flocculated at 20 to 25 rpm for 20 minutes. The fastest settling

time and the clarity of the product water were the factors considered for determining the optimum coagulant dosage.

3. Flocculation

An original sample size of ten gallons was used for each investigation with the hydrocyclones. For those studies requiring coagulation, flocculation was accomplished directly in the holding reservoir. An experimental laboratory agitator (variable speed) made by the Bench Scale Equipment Co. was used. The scale up from the jar studies was made by keeping the paddle area to tank surface area ratio constant. A small variation in paddle rotation speeds was necessary to obtain the best flocculation.

4. Pump

The pump used was a roller pump driven by a one horsepower, 110-220 volt a.c. motor. A by-pass valve was included in the configuration to allow control of the pressure drop and the flow rate through the system. The pump was calibrated for pressure drop versus flow rate by measuring the time for a known amount of water to pass through the system at a given pressure drop. Figure 4 shows the calibration curves for the pump with the insert and with the trap.

Experimental Procedures

1. Single-Pass Studies

Single-Pass studies were made to measure the degree of concentration of the clay slurry by the open-underflow hydrocyclone. A schematic of this system is shown in Figure 5. A volume of ten gallons of the clay slurry was pumped through the hydrocyclone from an original

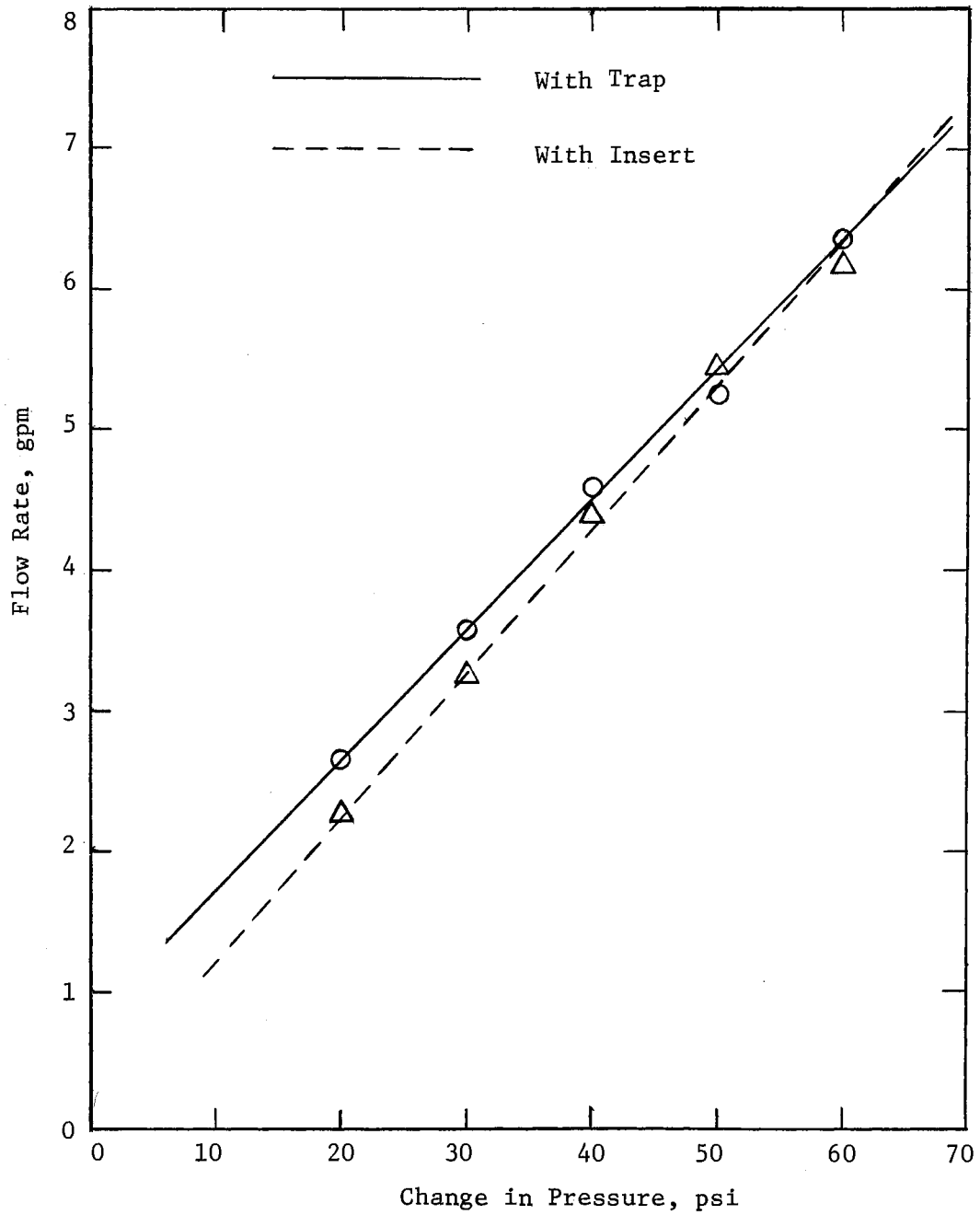

Figure 4. Pump Calibration Curves

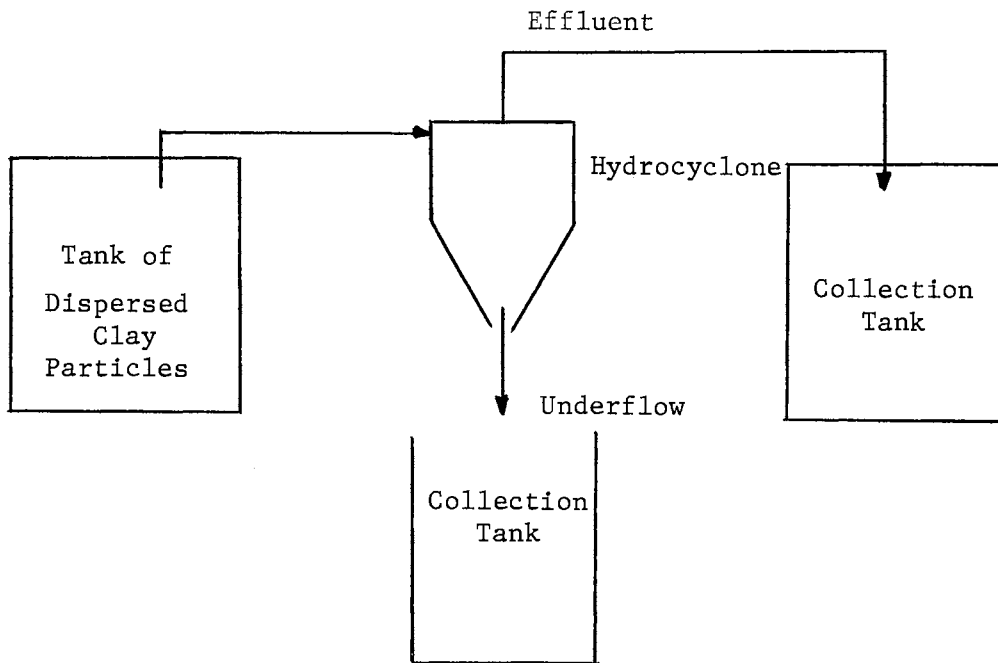

Figure 5. Flow Loop for Single-Pass Studies

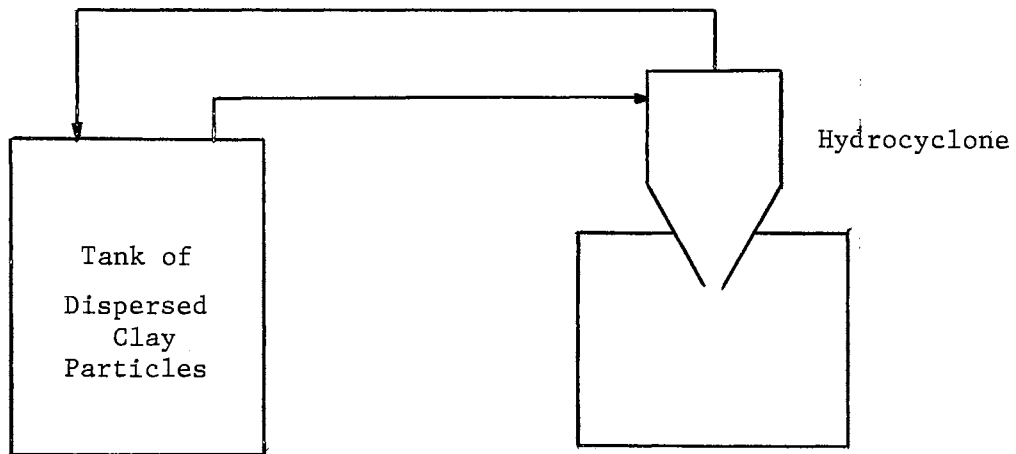

Figure 6. Flow Loop for Continuous Recycle Studies

tank into an effluent collection tank and an underflow collection tank. The underflow was allowed to fall freely at atmospheric pressure into the receiving container. After each pass was completed, samples for suspended solids determination were taken from the effluent and the underflow. Each succeeding pass consisted of repumping the effluent from the previous pass back through the system. The flow rate for hydrocyclone #1 was kept constant at 6.3 gpm, while its underflow was found to be 17%. Hydrocyclone #2 had a flow rate of 2 gpm and an underflow of 7.0%.

2. Continuous Recycle Studies

Continuous recycling was also studied. A schematic is shown in Figure 6. This was a closed system in which the effluent was continuously recycling into the original reservoir. A closed pot to hold the underflow was attached to the hydrocyclone. There were two types of continuous recycling runs investigated. Some runs made use of a contamination trap, while others did not. Samples for turbidity and/or solids determination were collected from the reservoir at various time periods after the initiation of the experiment. Only hydrocyclone #1 was used in these studies. Its flow rate varied for different investigations.

CHAPTER IV

EXPERIMENTAL RESULTS

General

The experimental results are divided into four main sections. The first section presents the single-pass results. These studies were made with and without coagulation with Hydrocyclone #1, and without coagulation with Hydrocyclone #2.

The second section deals with the continuous recycle studies without the contamination trap.

The third section, continuous recycle studies with trap, was further broken down into two parts. One part presents the results of using coagulation and of varying the flow rate through the hydrocyclone. Only Kaolinite was used for these investigations. The other part shows the results of using materials of different size ranges. In this part, the removal of solids is compared with the removal of turbidity.

The last section presents the effects of the coagulants on hydrocyclone performance and the results of the jar test studies

It should be noted that although all of the initial clay slurries were mixed at 100 mg/l, most of the initial suspended solids measurements indicate values well below this. There are several possible explanations for this discrepancy. First, the clay may not have been completely dry. Water molecules attached to the surface of the clay

particles naturally increase the total weight. Also, the solids were determined by filtering through a .45 membrane filter, dried and weighed. Some of the particles could have been small enough to pass through the filter, and the oven drying of the sample would drive off much of the water initially present.

Single-Pass Studies

The results of the single-pass studies for Hydrocyclone #1 are given in Figures 7, 8 and 9. Coagulation was used for these studies. Alum and C-31 were added, and the system was flocculated before it was pumped through the hydrocyclone. Optimum coagulant dosages are given in Table V.

Figure 7 shows that on the first pass the PRC went from a solids concentration of 76 mg/l to 272 mg/l in the underflow and 44 mg/l in the effluent. After the first pass the effluent solids remained about constant. The underflow solids decreased rapidly on the second pass then became almost constant. The RMGC coagulated system (Figure 8) shows much the same pattern of removal as the PRC. The difference is that the original solids concentration of the RMGC system was 96 mg/l. On the first pass, the solids went to 132 mg/l in the underflow and 76 mg/l in the effluent. There was a slight decrease of effluent solids for each succeeding pass. The underflow solids decreased slowly to a level of almost 100 mg/l. Figure 9 shows the single pass results for the coagulated Kaolinite system. Very little separation was achieved. The original solids of 100 mg/l stayed constant while the underflow solids went from 108 mg/l on the first pass to 102 mg/l on the last pass. From these plots, values were taken to construct the

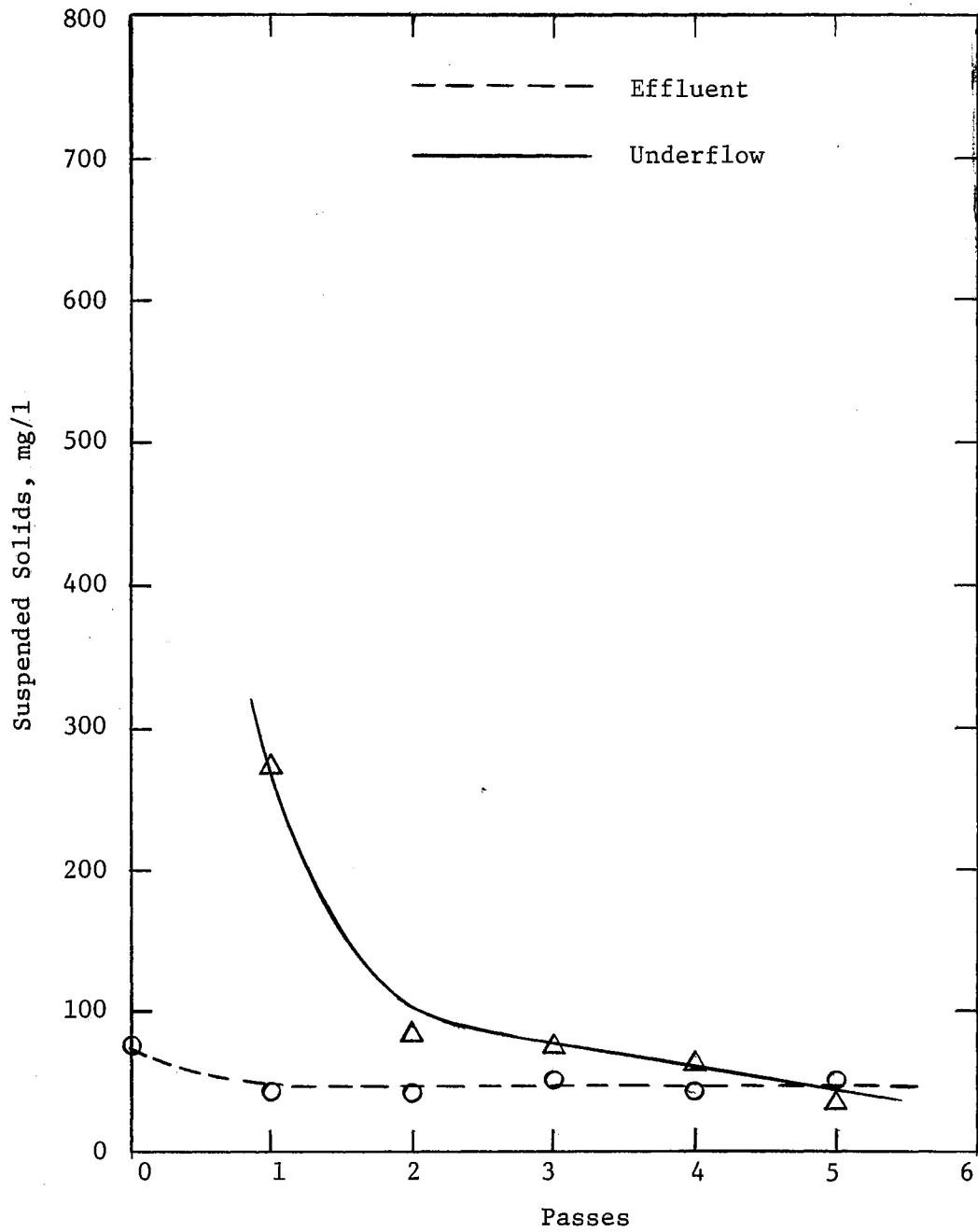

Figure 7. Single-Pass Results, Hydrocyclone #1, PRC With Coagulation

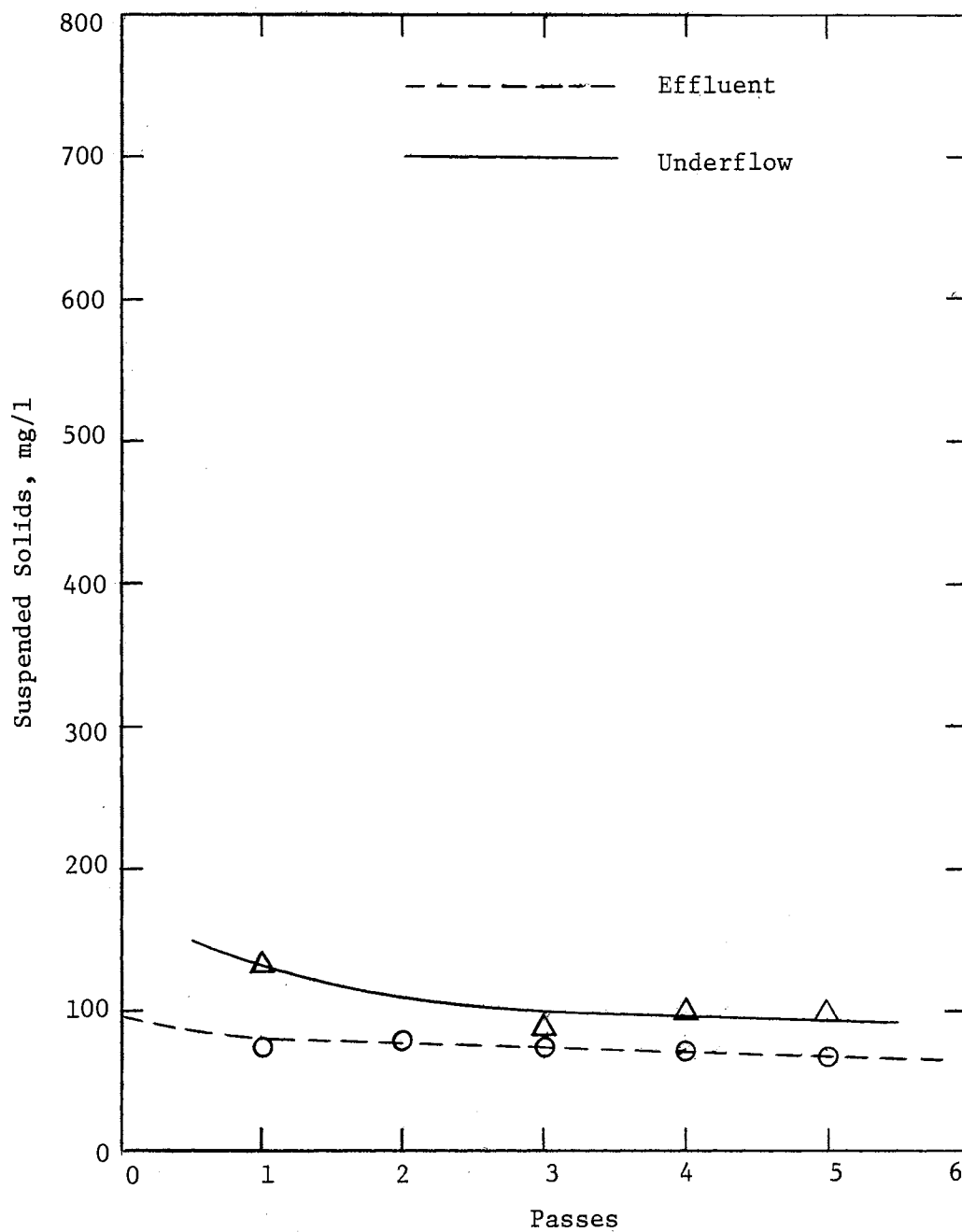

Figure 8. Single-Pass Results, Hydrocyclone #1, RMGC With Coagulation

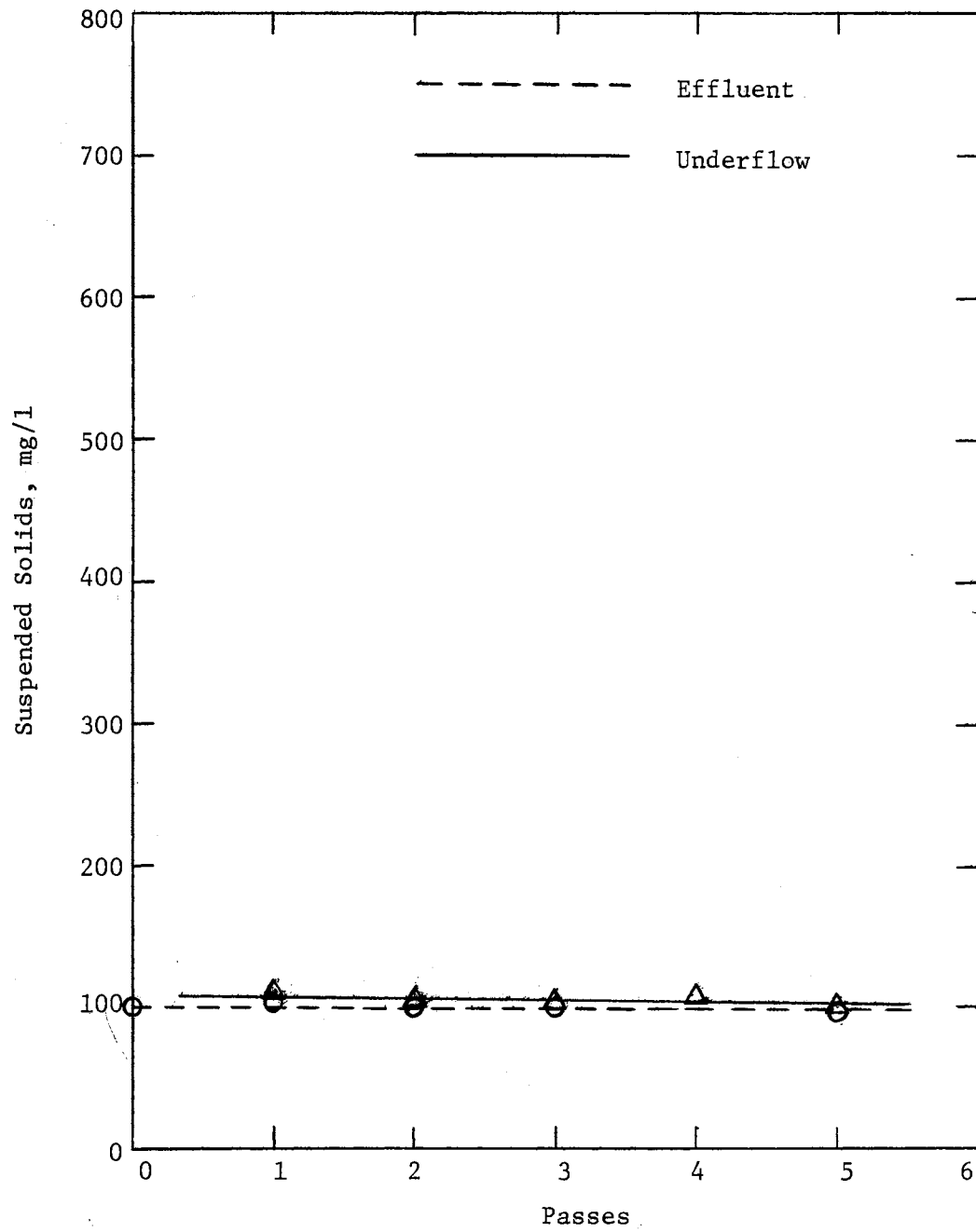

Figure 9. Single-Pass Results, Hydrocyclone #1, Kaolinite with Coagulation

concentration and separation curves (Figures 10 and 11). Figure 10 shows that Hydrocyclone #1 achieved the greatest concentration with PRC, this concentration being about 260%. The concentration of RMGC was much less than PRC. However, the concentrations of the RMGC and the Kaolinite were almost constant at about 35% and 5% respectively.

The separation efficiency obtained with each clay is shown in Figure 11. It can be seen that the highest level of separation was obtained with PRC. No separation was obtained with the Kaolinite. The greatest separation occurred on the first pass with PRC and RMGC and then became almost constant.

Single-pass studies without coagulation were also made with Hydrocyclone #1. The results of these studies are shown in Figures 12, 13 and 14. Figure 12 shows that the solids concentration of PRC without coagulation which was initially 64 mg/l was 260 mg/l in the underflow and 43 mg/l in the effluent. The greatest underflow concentration occurred in the first pass. The solids decreased slowly on the succeeding passes until they became almost constant in both the underflow and the effluent. It is interesting to note that the effluent became constant at a solids level of about 20 mg/l, whereas, in the case of coagulation (Figure 7) the effluent became constant at a solids level of about 30 mg/l.

The results obtained for the RMGC using Hydrocyclone #1 without coagulation are presented in Figure 13. The performance pattern is much the same as it was for the PRC. The initial solids concentration was 60 mg/l and after the first pass the solids were 44 mg/l in the effluent and 156 mg/l in the underflow. This shows the solids were being concentrated to a high degree. After the first pass, the solids

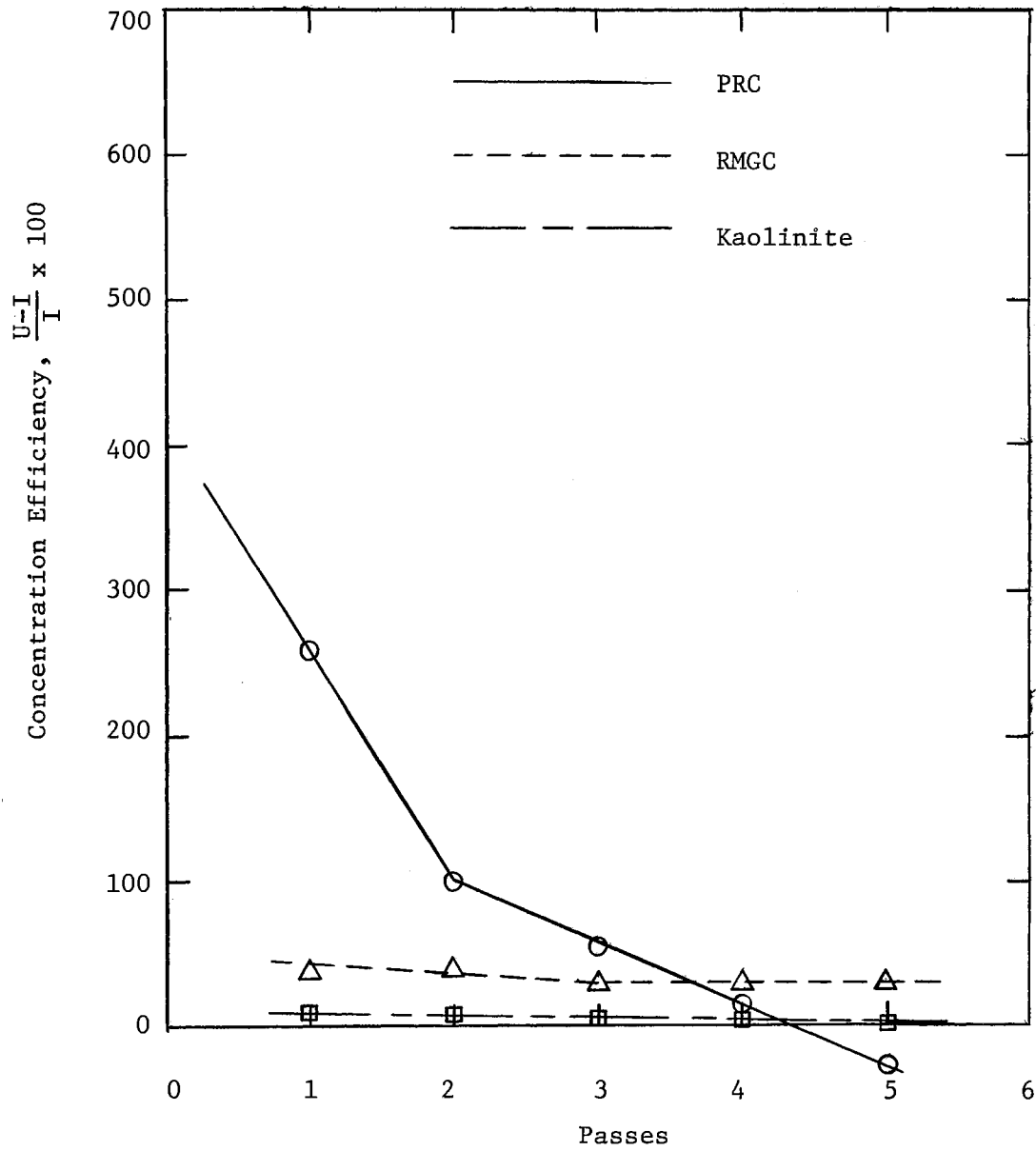

Figure 10. Hydrocyclone #1, Concentration Efficiency With Coagulation, (U = Solids Concentration in Underflow, I = Solids Concentration in Inlet Flow)

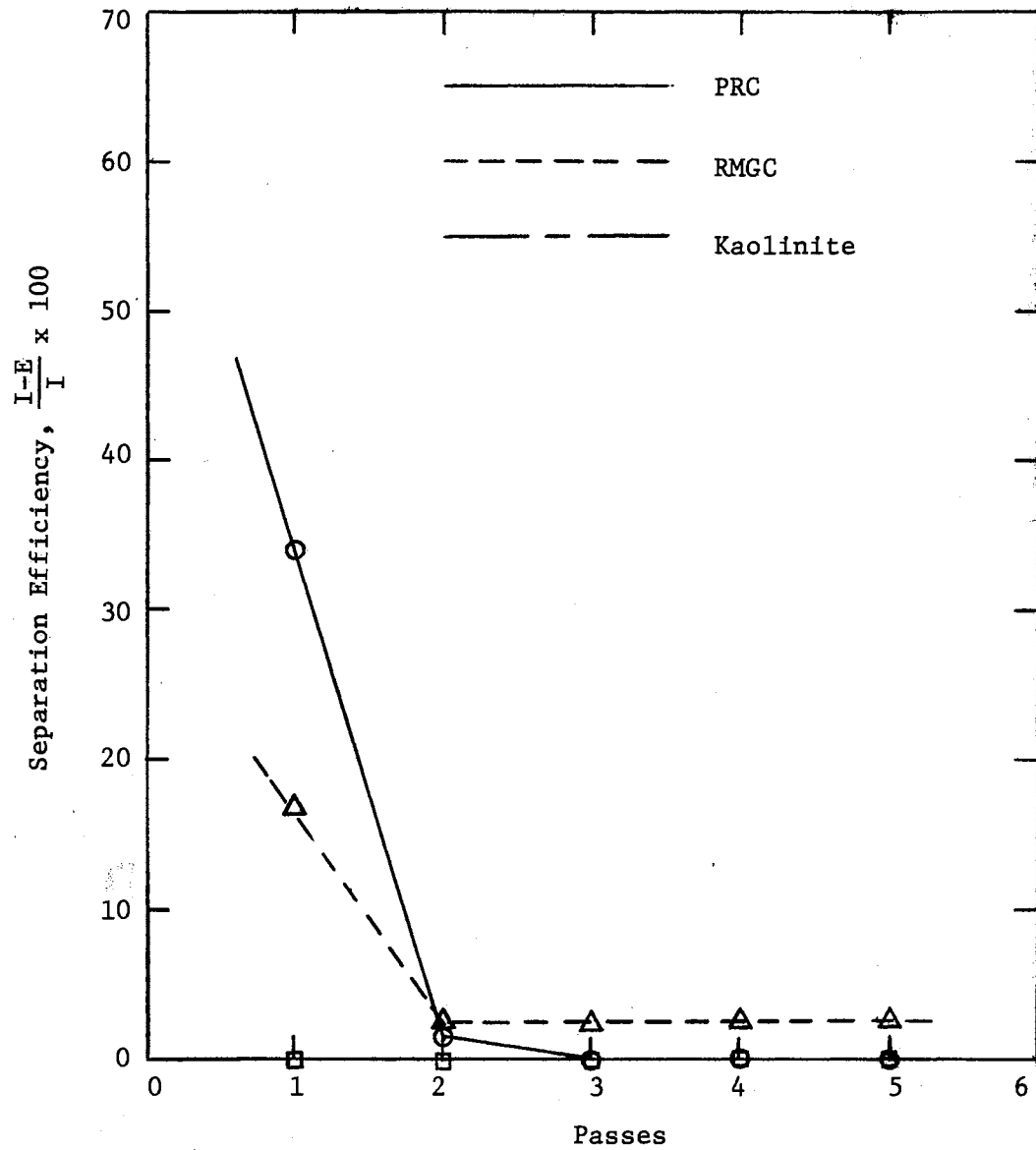

Figure 11. Hydrocyclone #1, Separation Efficiency With Coagulation, (E = Solids Concentration in Overflow Effluent, I = Solids Concentration in Inlet Flow)

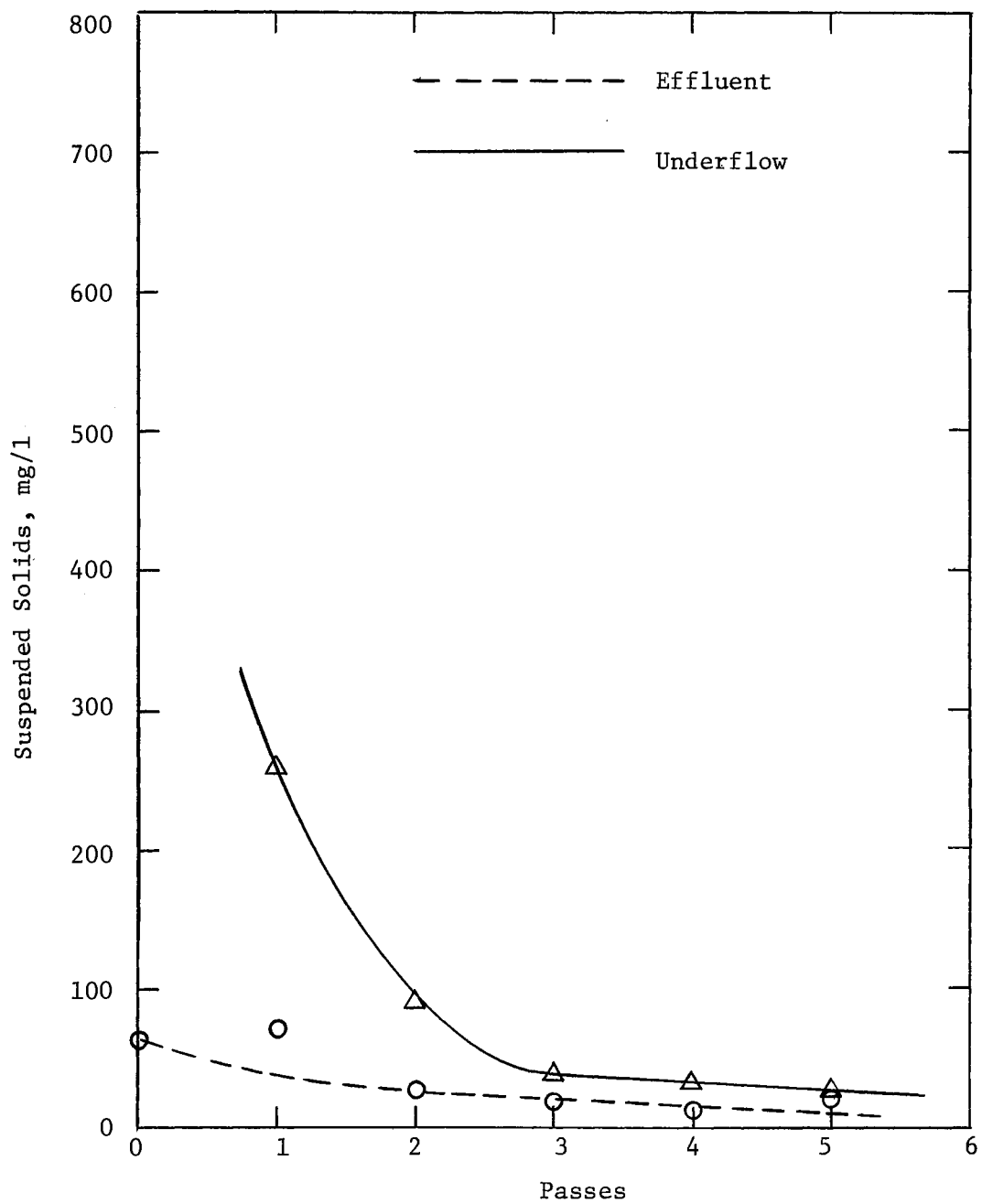

Figure 12. Single-Pass Results, Hydrocyclone #1, PRC Without Coagulation

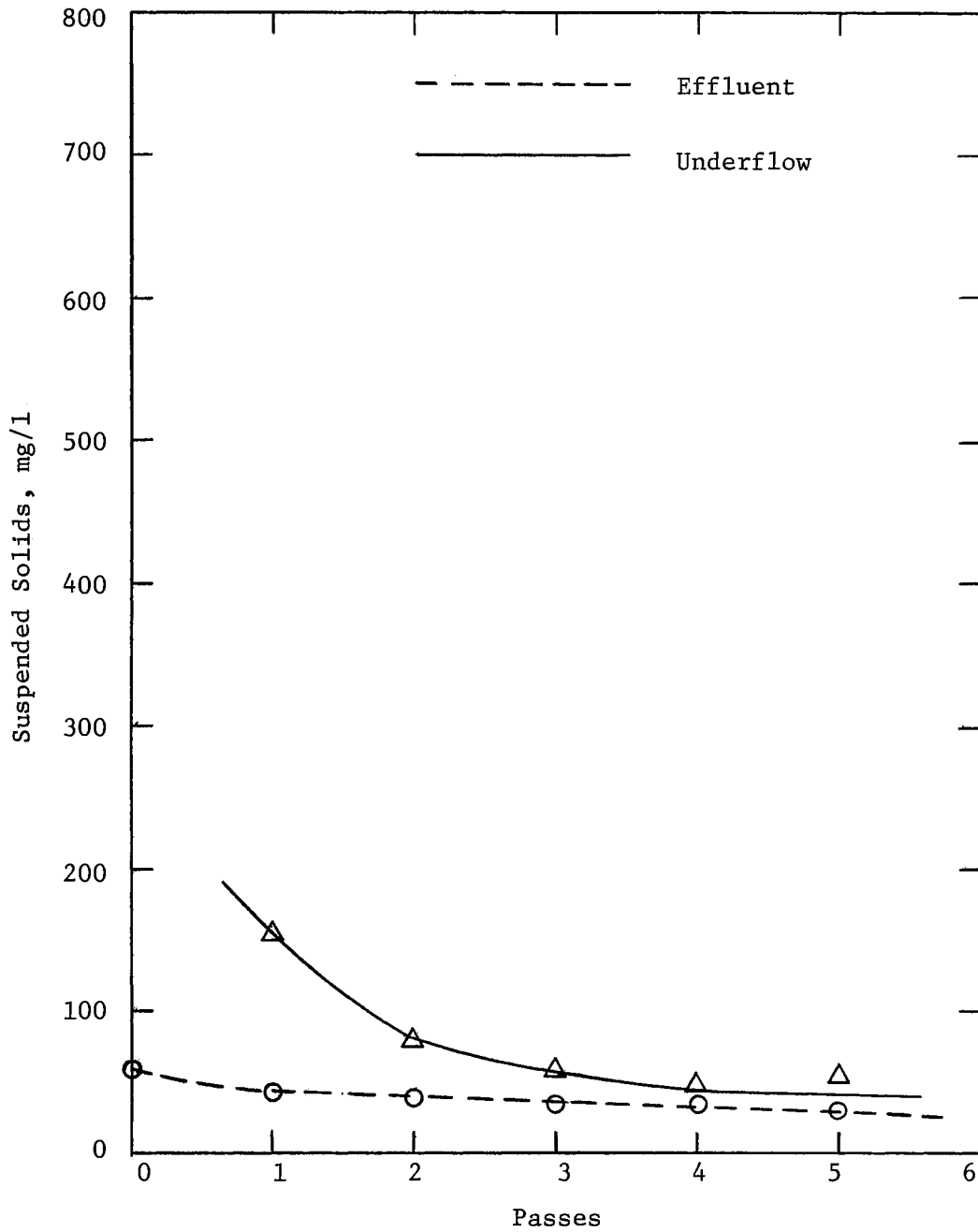

Figure 13. Single-Pass Results, Hydrocyclone #1, RMGC Without Coagulation

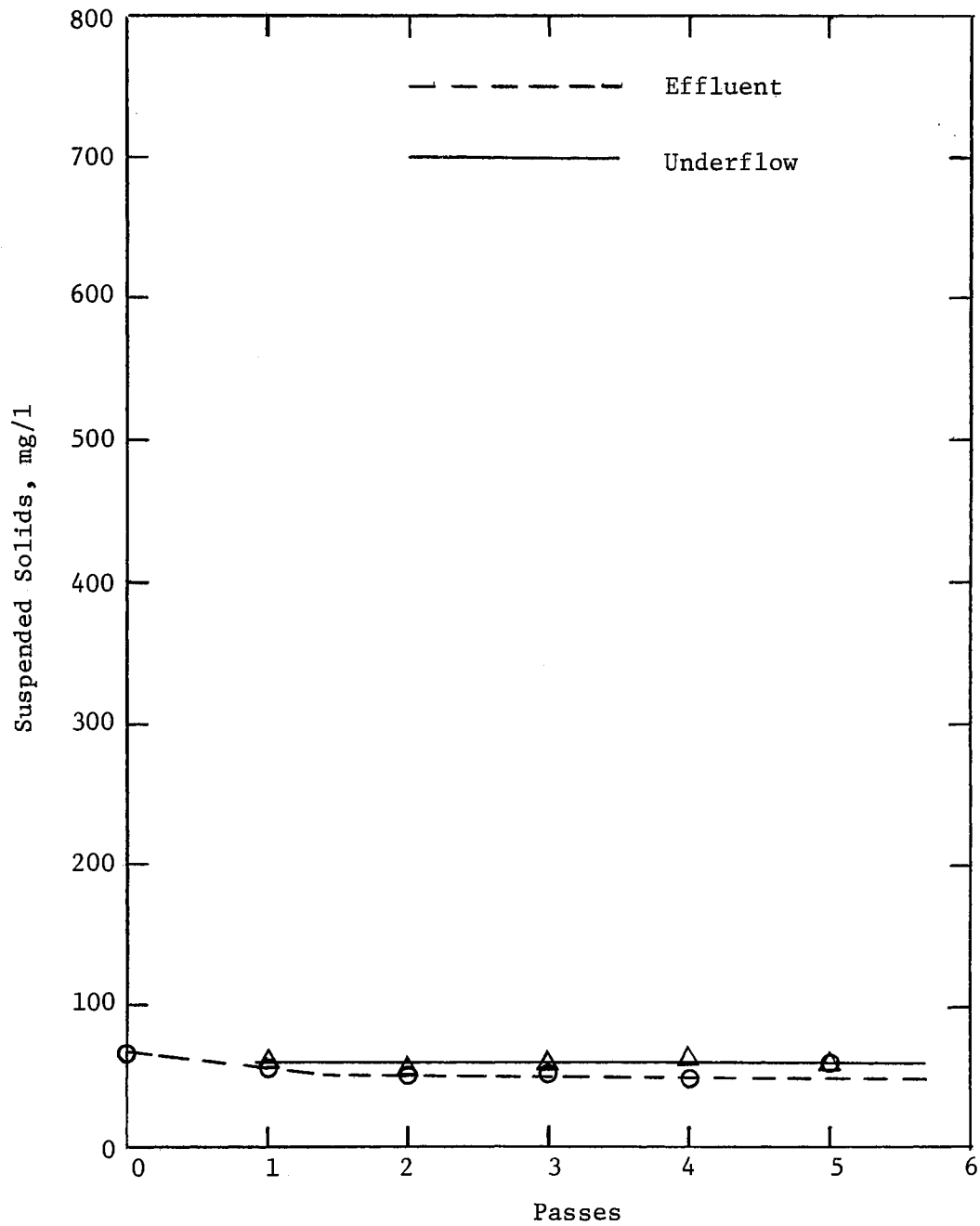

Figure 14. Single-Pass Results, Hydrocyclone #1,
Kaolinite Without Coagulation

levels decreased slowly in both the effluent and underflow until they become nearly constant at 30 mg/l and 45 mg/l respectively. These are much lower concentrations than were achieved when coagulation was used (Figure 8). With coagulation, the effluent and underflow solids concentration became nearly constant at 70 mg/l and 95 mg/l. This shows a difference of 40 to 50 mg/l between the two systems. Figure 14 shows that little removal was achieved with the Kaolinite. The effluent solids concentration decreased from 70 mg/l to 50 mg/l. This is only a 20 mg/l difference, but as seen in Figure 9, when coagulation was used, there was no decrease in the effluent solids concentration. The underflow concentration remained constant at 60 mg/l. No concentration was shown on the first pass.

Concentration and separation curves were again constructed and are shown in Figures 15 and 16. Figure 15 shows that the first pass concentration of PRC was about 300%. The concentration of RMGC was less than PRC but the concentration patterns of the two were similar. Again the highest concentrations were obtained on the first pass. Kaolinite showed a negative concentration on the first pass.

The separation efficiency obtained with each clay is shown in Figure 16. The highest level of separation was seen for PRC at about 34%. A separation efficiency of 16% was obtained for Kaolinite even though a negative concentration was observed. The greatest separation was achieved on the first pass, but subsequent separations did not decrease as rapidly as the separations in the previous studies with coagulation shown in Figure 11.

Single-Pass studies without coagulation were also made with Hydrocyclone #2. The results of these studies are presented in

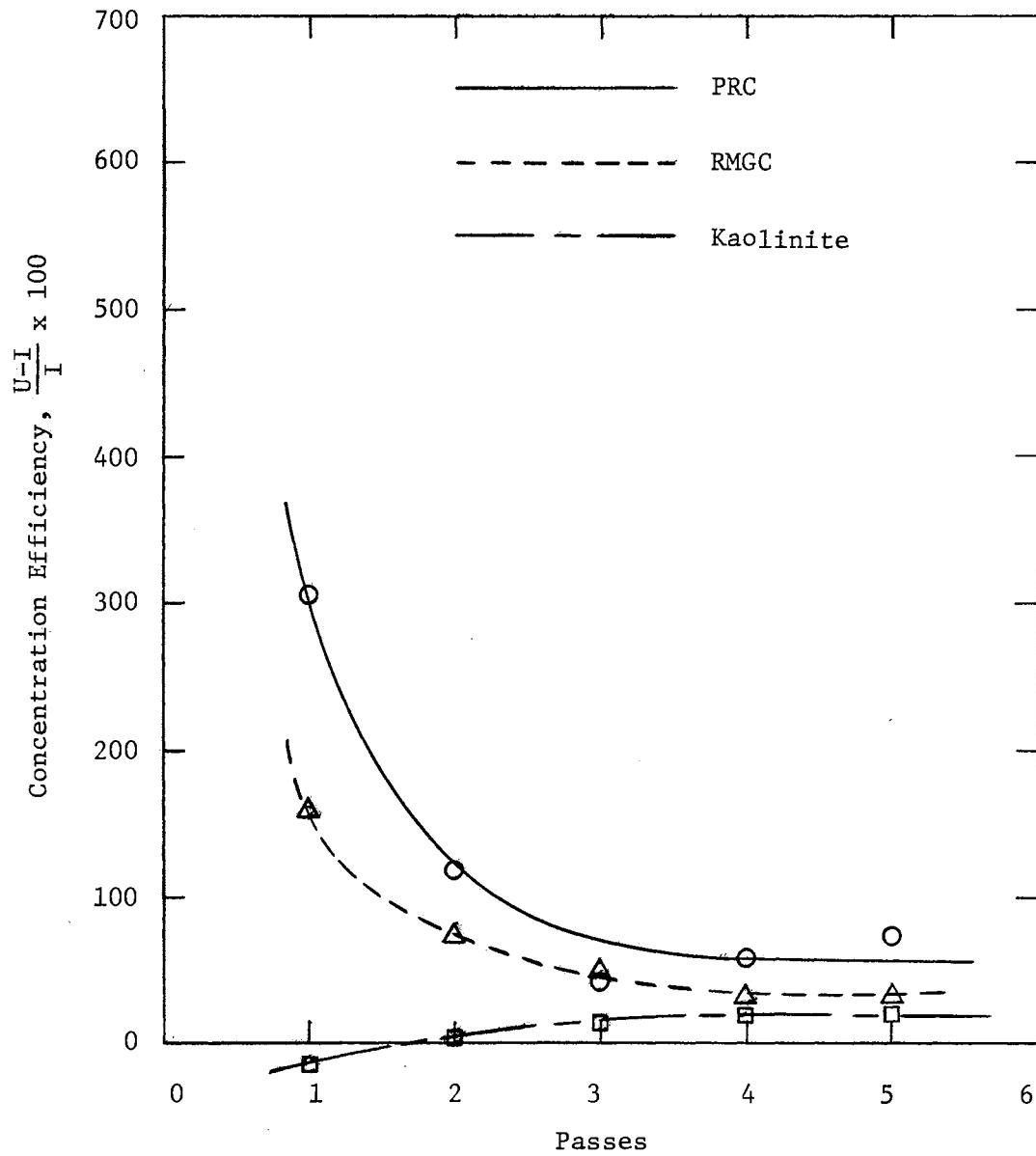

Figure 15. Hydrocyclone #1, Concentration Efficiency Without Coagulation, (U = Solids Concentration in Underflow, I = Solids Concentration in Inlet Flow)

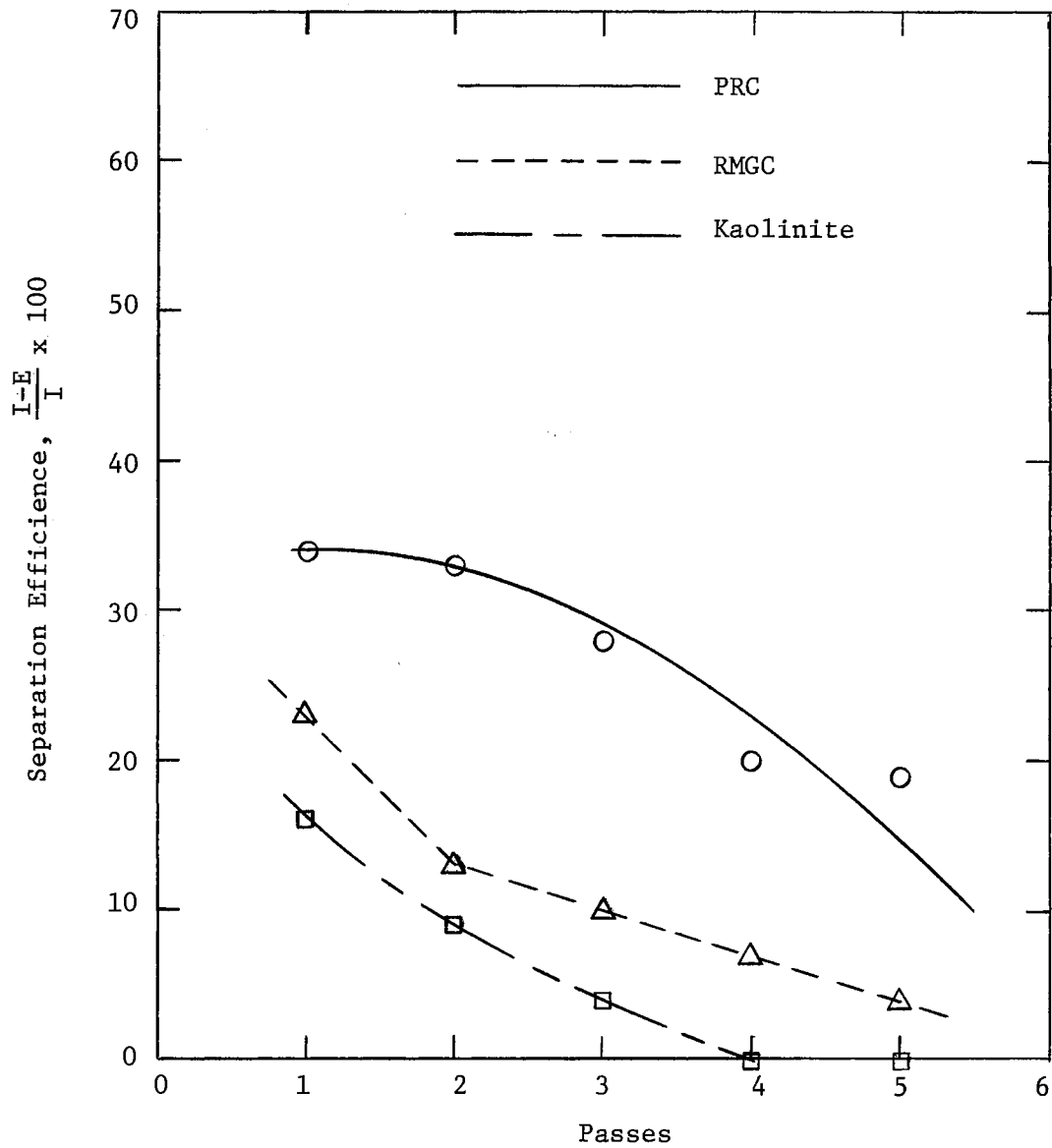

Figure 16. Hydrocyclone #1, Separation Efficiency Without Coagulation (E = Solids Concentration in Overflow Effluent, I = Solids Concentration in Inlet Feed)

Figures 17, 18 and 19. Figure 17 shows that the solids concentration for PRC, initially 116 mg/l, went to 736 mg/l in the underflow and 40 mg/l in the effluent on the first pass. The solids level decreased slowly on the subsequent passes to 70 mg/l in the underflow and 20 mg/l in the effluent. The PRC solids concentration without coagulation using Hydrocyclone #1 went from 64 mg/l original concentration to 260 mg/l in the underflow after the first pass (Figure 12). Thus, the smaller hydrocyclone achieved a much greater concentration in the underflow.

The results for RMGC using Hydrocyclone #2 are shown in Figure 18. The original solids concentration was 80 mg/l. After the first pass, the effluent concentration was 48 mg/l and the underflow concentration was 496 mg/l. The highest underflow solids concentration occurred on the first pass. The solids decreased rapidly in the succeeding passes until the fourth pass, at which time the solids started to level out at about 50 mg/l. After the first pass, the effluent solids decreased at a linear rate and did not appear to be leveling out. After five passes the effluent solids had reached 30 mg/l. These are approximately the same levels reached with Hydrocyclone #1 (Figure 13).

Figure 19 shows the results of the study using Kaolinite. The original solids concentration was 116 mg/l. The effluent solids went to 100 mg/l after five passes. This shows that little removal was achieved. The solids concentration in the underflow was 160 mg/l after the first pass, and decreased slowly.

Concentration and separation curves (Figures 20 and 21) were constructed using the values from the preceding data for Hydrocyclone #2. The concentrations of the PRC and RMGC shown in Figure 20 were

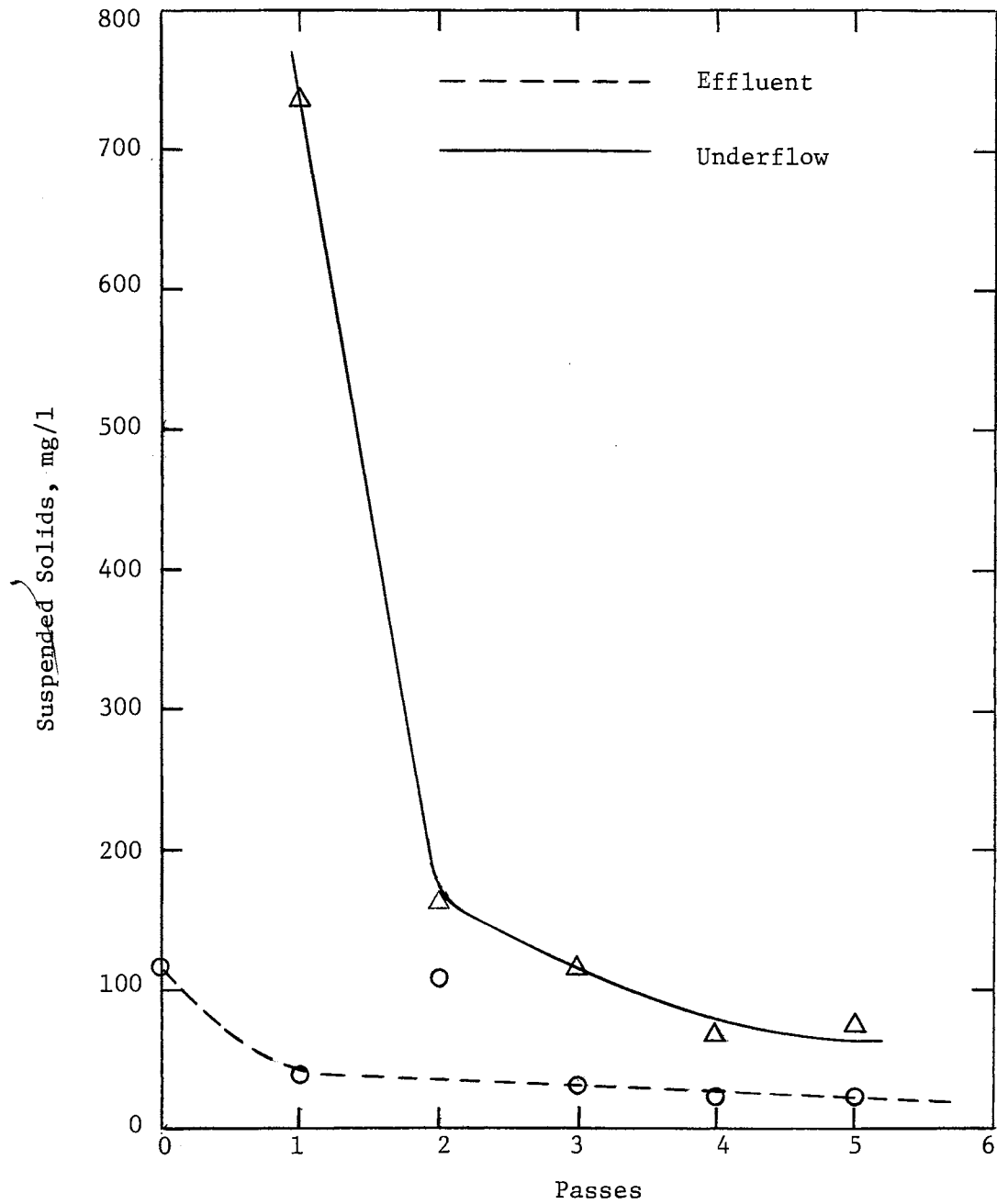

Figure 17. Single-Pass Results, Hydrocyclone #2, PRC Without Coagulation

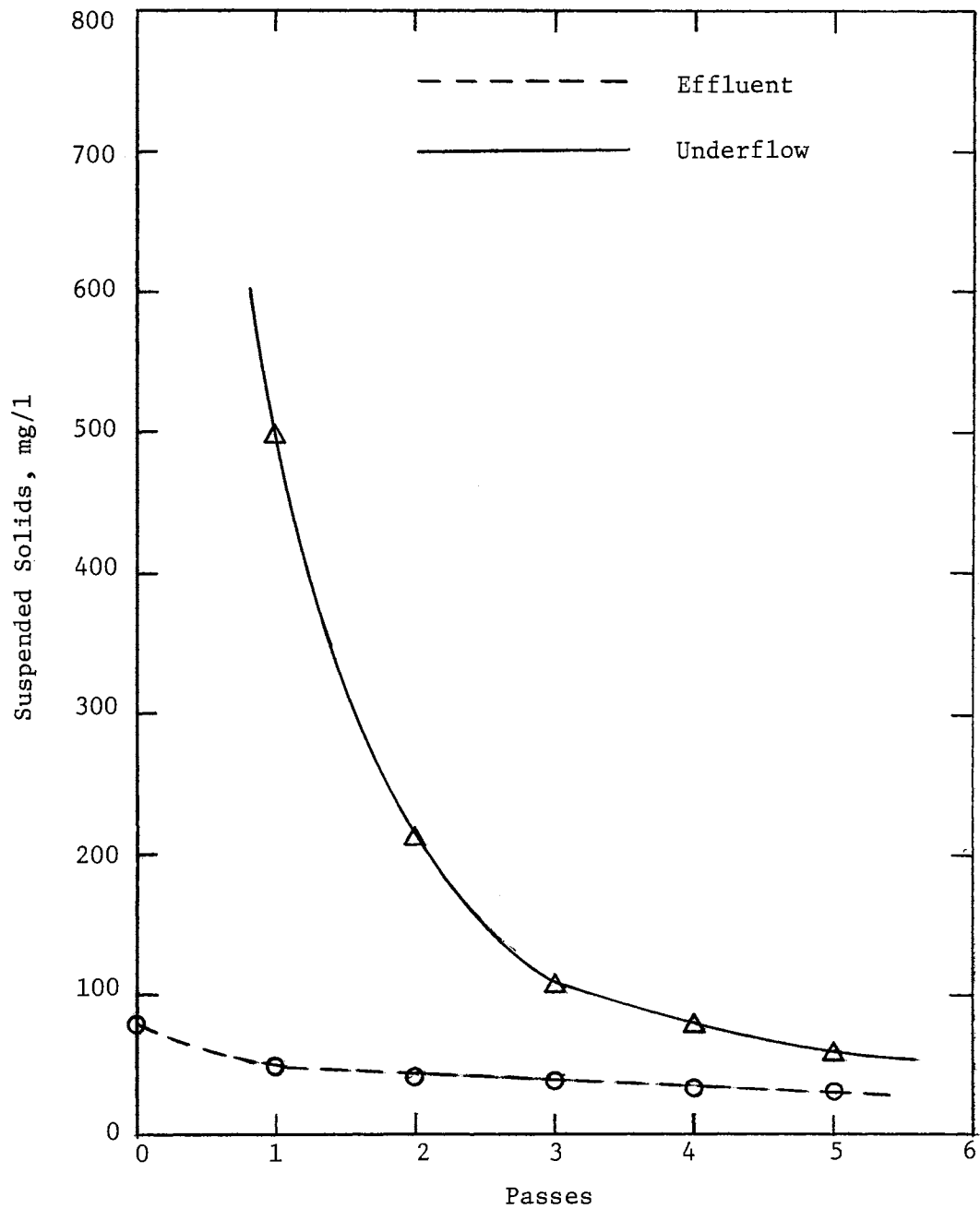

Figure 18. Single-Pass Results, Hydrocyclone #2, RMGC Without Coagulation

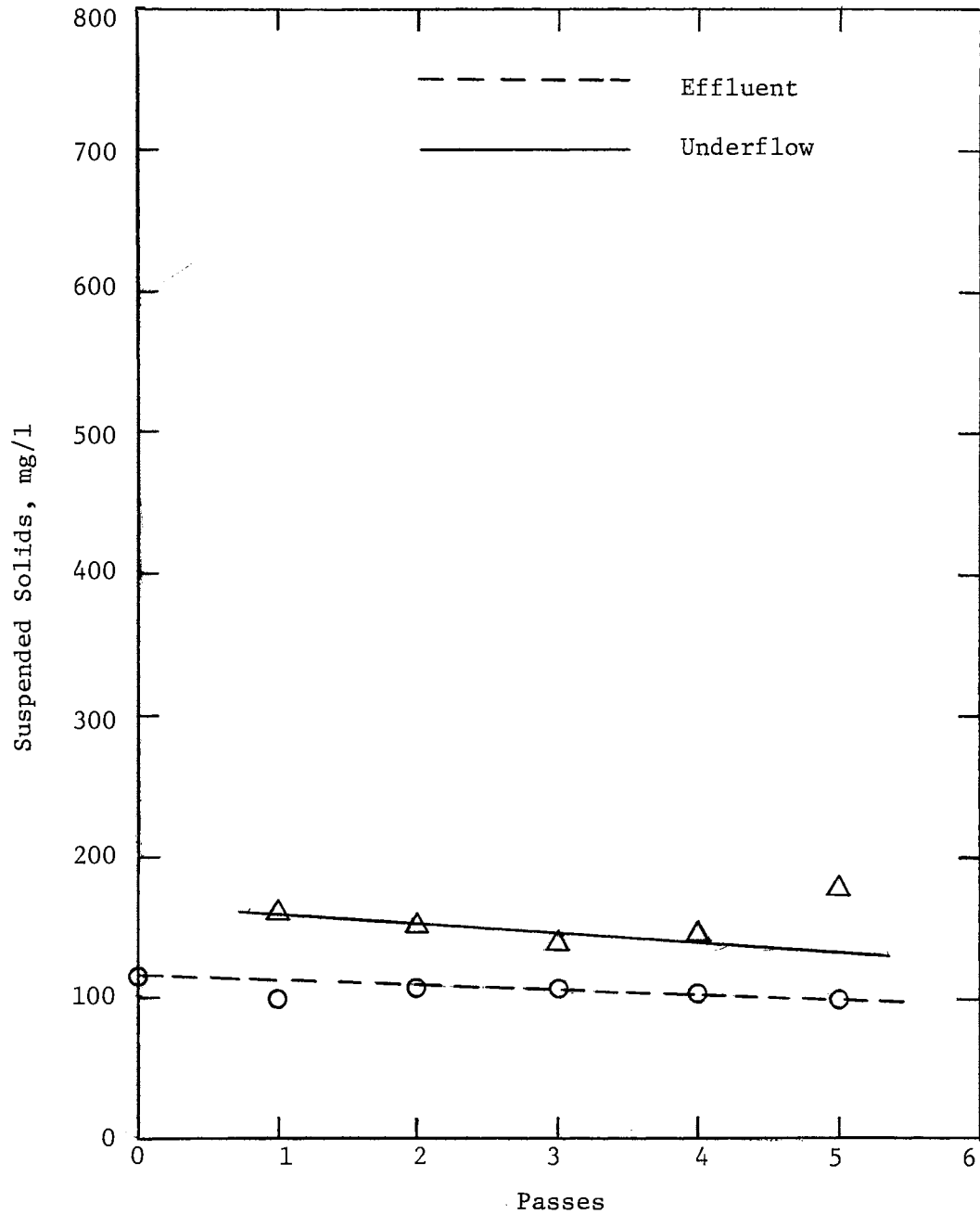

Figure 19. Single-Pass Results, Hydrocyclone #2,
Kaolinite Without Coagulant

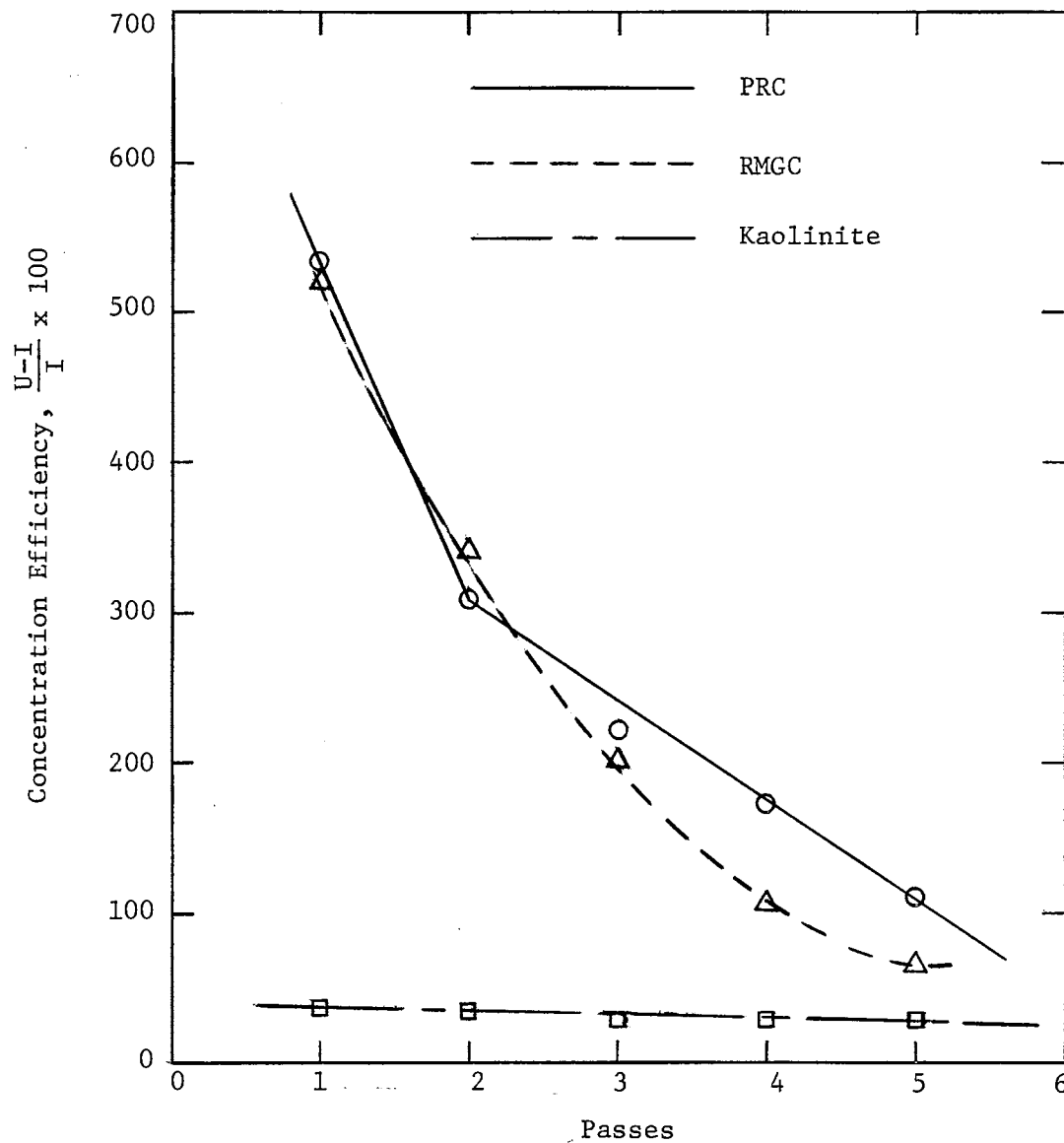

Figure 20. Hydrocyclone #2 Concentration Efficiency Without Coagulation (U = Solids Concentration in Underflow, I = Solids Concentration in Inlet Feed)

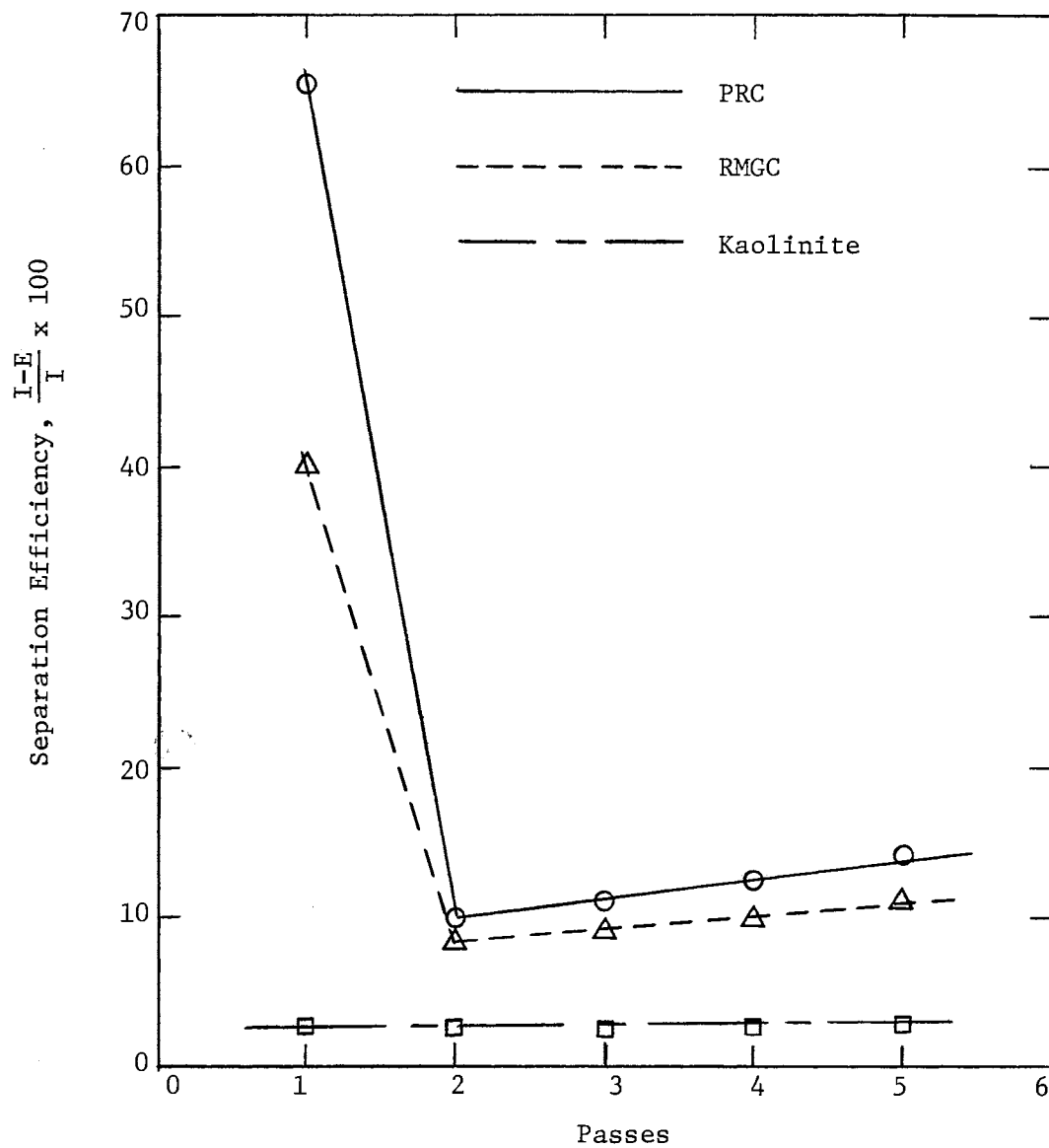

Figure 21. Hydrocyclone #2, Separation Efficiency Without Coagulation (E = Solids Concentration in Overflow Effluent, I = Solids Concentration in Inlet Feed)

nearly identical, starting at over 500% on the first pass and decreasing rapidly to about 100% on the fifth pass. The concentration of Kaolinite was nearly constant at 30%.

Figure 21 shows the separation efficiency of Hydrocyclone #2 for each clay. The greatest separation was achieved for PRC and it occurred on the first pass. The efficiency dropped sharply on the second pass and then slightly increased with each subsequent pass. RMGC behaved similarly, the only difference being that the separation for RMGC was 40% while that of PRC was 65%. The separation of the Kaolinite remained nearly constant at about 3%.

The cumulative efficiencies after each pass for each hydrocyclone are shown in Figures 22, 23 and 24. Coagulation was not used. Figure 22 shows the efficiencies achieved for PRC. Hydrocyclone #2 achieved a removal of 66% on the first pass. The removal increased linearly to 83% on the subsequent passes. On the fifth pass the removal was still increasing. Hydrocyclone #1, on the other hand, achieved only 33% removal on the first pass. Removal was completed on the fourth pass at 77%.

The cumulative removal efficiencies for RMGC, shown in Figure 23, followed the same pattern as PRC. The efficiencies were lower than for PRC, however. After the first pass, Hydrocyclone #2 achieved a removal of 40% which increased linearly to 60% on the fifth pass. The removal efficiency for Hydrocyclone #1 increased more slowly and began to level out at 40%.

The situation was reversed with Kaolinite as shown in Figure 24. The removal efficiency of Hydrocyclone #1 was greater than that of Hydrocyclone #2. Hydrocyclone #1 had removed 27% by the third pass and

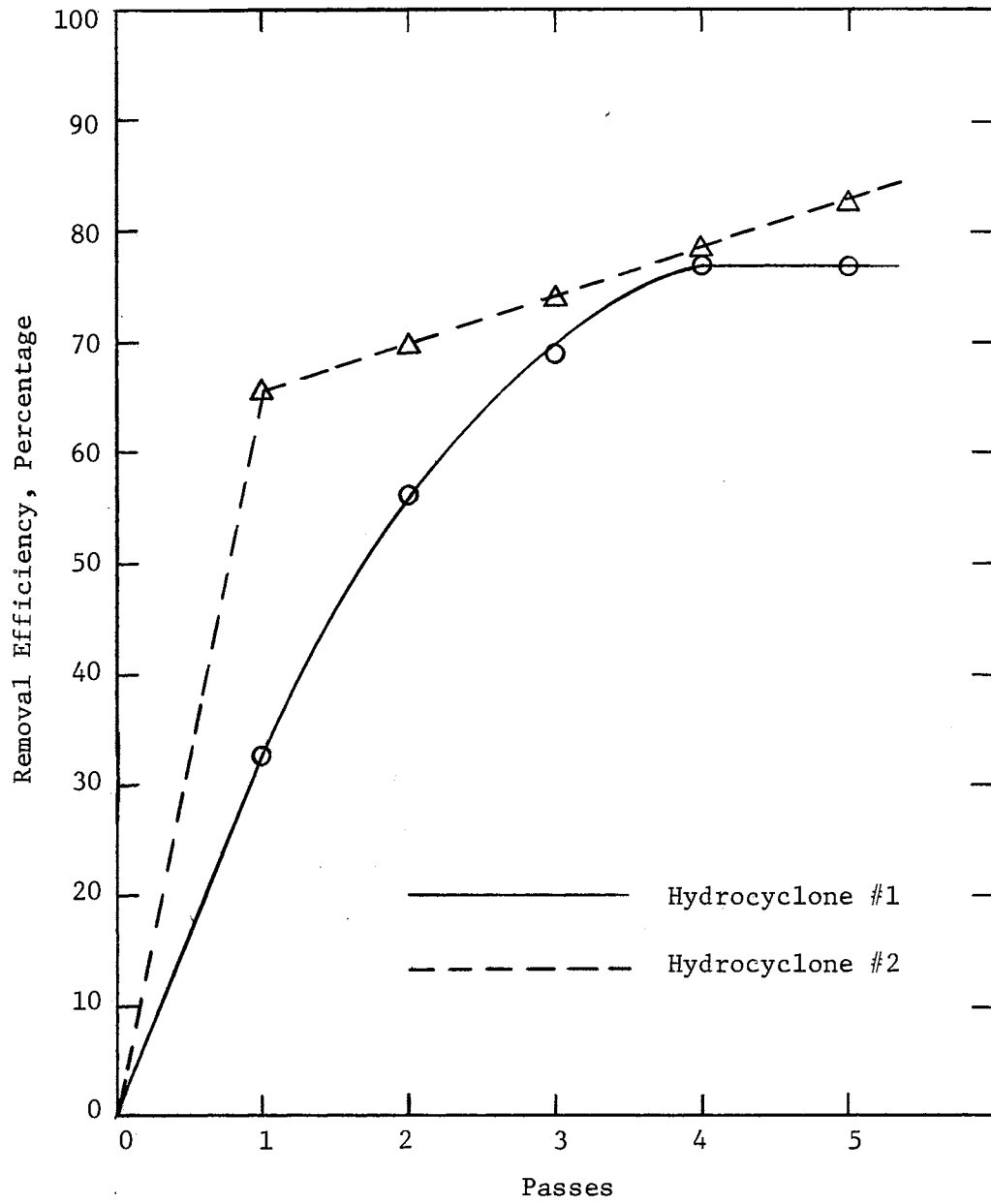

Figure 22. Single-Pass Cumulative Removal Efficiency for PRC

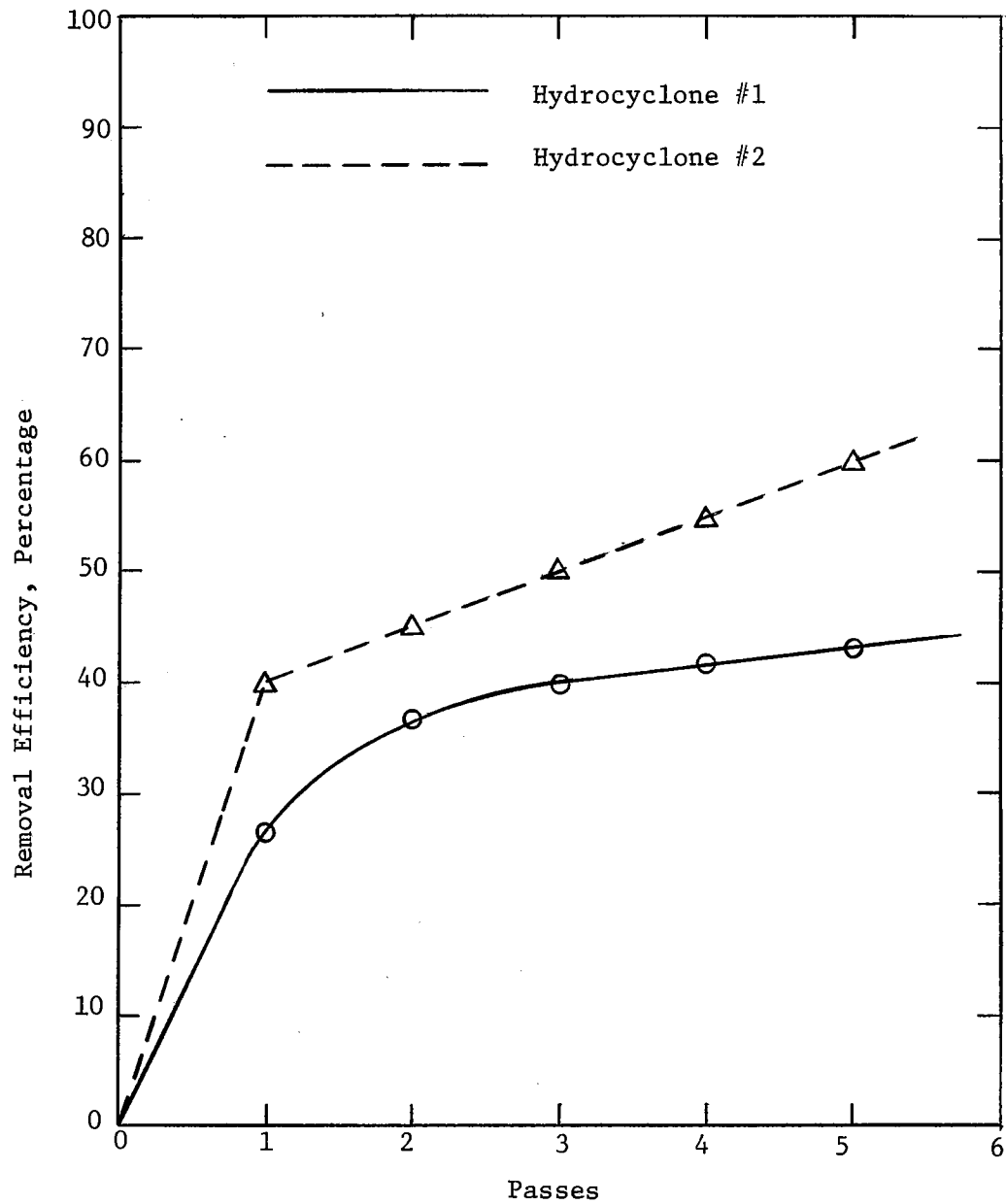

Figure 23. Single-Pass Cumulative Removal Efficiency for RMGC

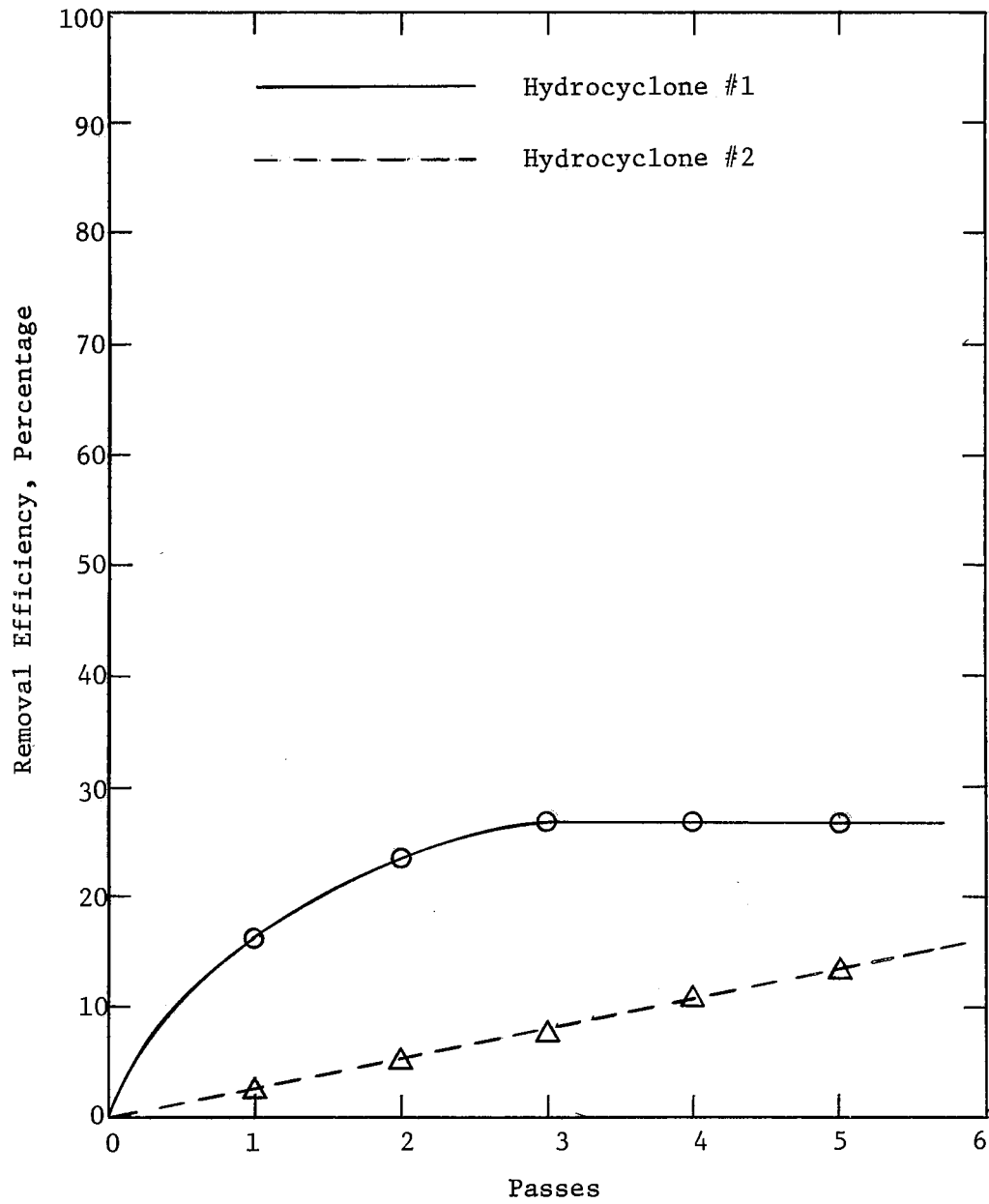

Figure 24. Single-Pass Cumulative Removal Efficiency for Kaolinite

then showed no additional removal. The cumulative removal efficiency of Hydrocyclone #2 increased linearly from 0 to 13% through the fifth pass and was still increasing.

Continuous Recycle Studies Without Trap

Continuous recycle studies without trap were made for each clay with Hydrocyclone #1. No coagulation was involved. The results were measured by turbidity and by suspended solids. Figure 25 shows turbidity versus time, while Figure 26 shows suspended solids versus time. Both plots are on semi-log graphs, and both figures represent the same studies. Figure 25 shows that there was no decrease in turbidity for any clay. Figure 26 shows that there was no decrease in solids for Kaolinite, and only a slight decrease for PRC and RMGC. Thus, all but the largest particles were not kept in the collection pot. It is notable that there is a large difference in initial turbidities, but little difference in initial solids level. Thus, turbidity and solids must be two separate parameters.

Continuous Recycle Studies With Trap

1. Varied Flow Rates

Continuous recycle studies with a contamination trap were made with Hydrocyclone #1. Hydrocyclone performance was investigated based on coagulation and varied flow rates. The results of the studies made with coagulation (alum as the coagulant) are presented in Figure 27. The data is shown on a semi-log plot. The data plots as a straight line, therefore, the data follows first order kinetics. The slope of each line represents the turbidity removal rate at that flow

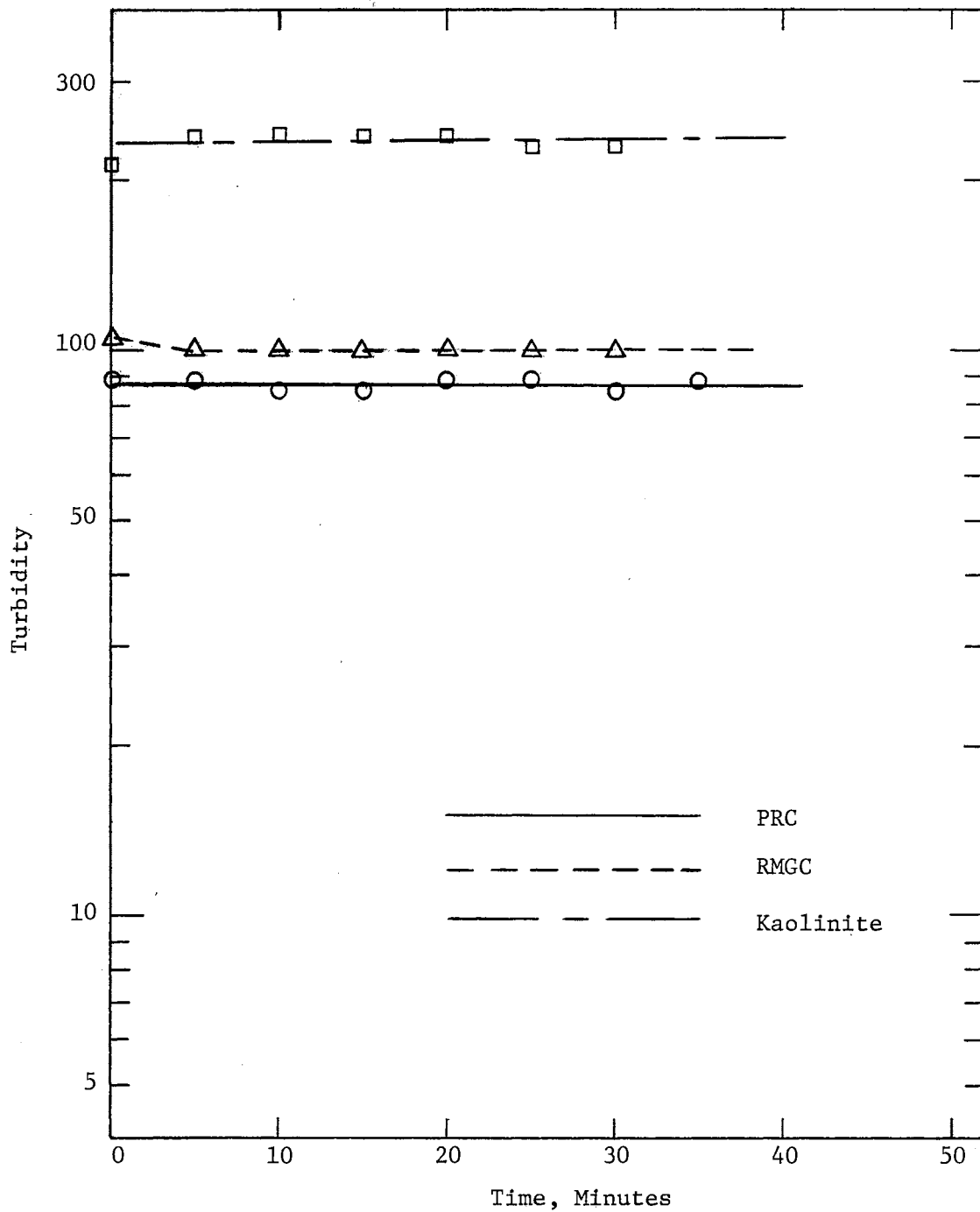

Figure 25. Continuous Recycle Results, Removal of Turbidity With Closed Pot

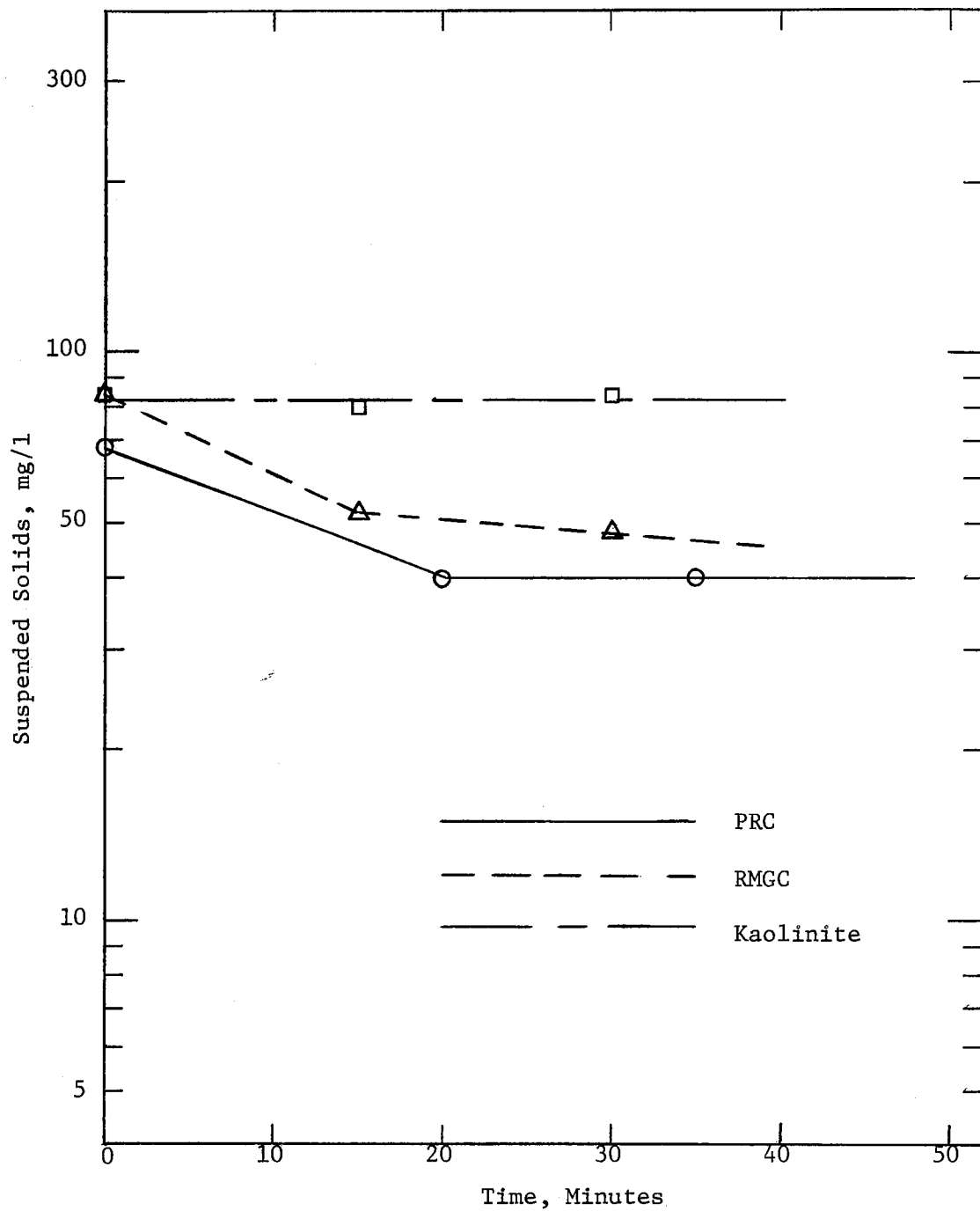

Figure 26. Continuous Recycle Results, Removal of Solids With Closed Pot

rate. Figure 27 shows that the removal rate increases as the flow rate increases. The calculated removal rates are presented in Table III.

TABLE III
REMOVAL RATES

Flow Rates	Coagulation	No Coagulation
1.7 gpm	.0175	.0204
3.6 gpm	.0272	.0377
4.6 gpm	.0313	.0454

(Minutes⁻¹) of turbidity for continuous recycle studies

The results of the studies made without coagulation are shown in Figure 28. This data also plots as straight lines on a semi-log plot. Here again, the removal rate increases with an increase in flow rate. The removal rates are shown in Table III.

By comparing the removal rates for each case in Table III, it is seen that turbidity removal increases as flow rate increases for both situations. However, at each flow rate the removal rate was higher when coagulation was not used.

Not shown in Figures 27 and 28 is the fact that a turbidity reading of zero was reached in most cases. However, at approximately 10 turbidity units, the data no longer followed first order kinetics.

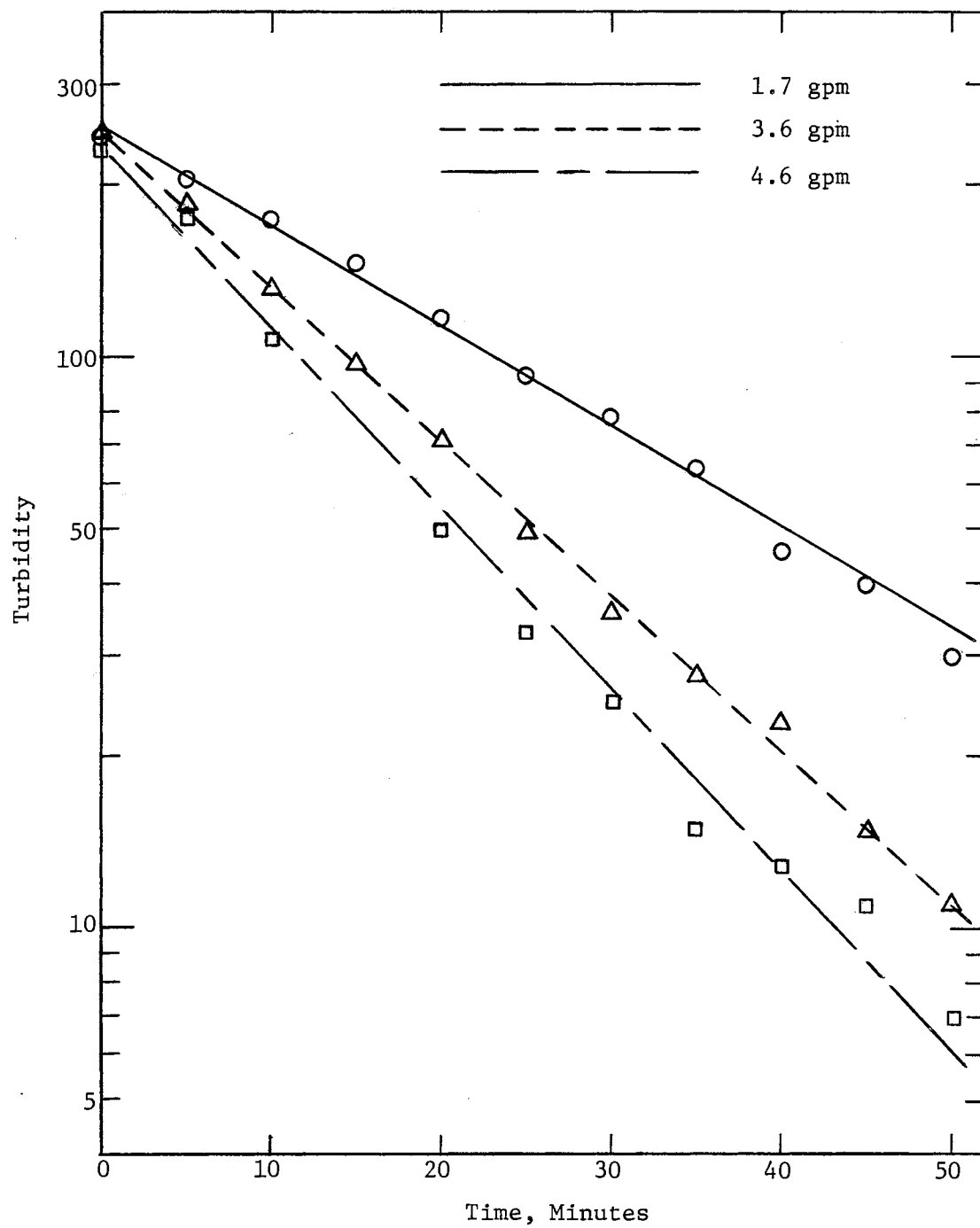

Figure 27. Continuous Recycle Results, Removal of Kaolinite Turbidity Using Coagulation

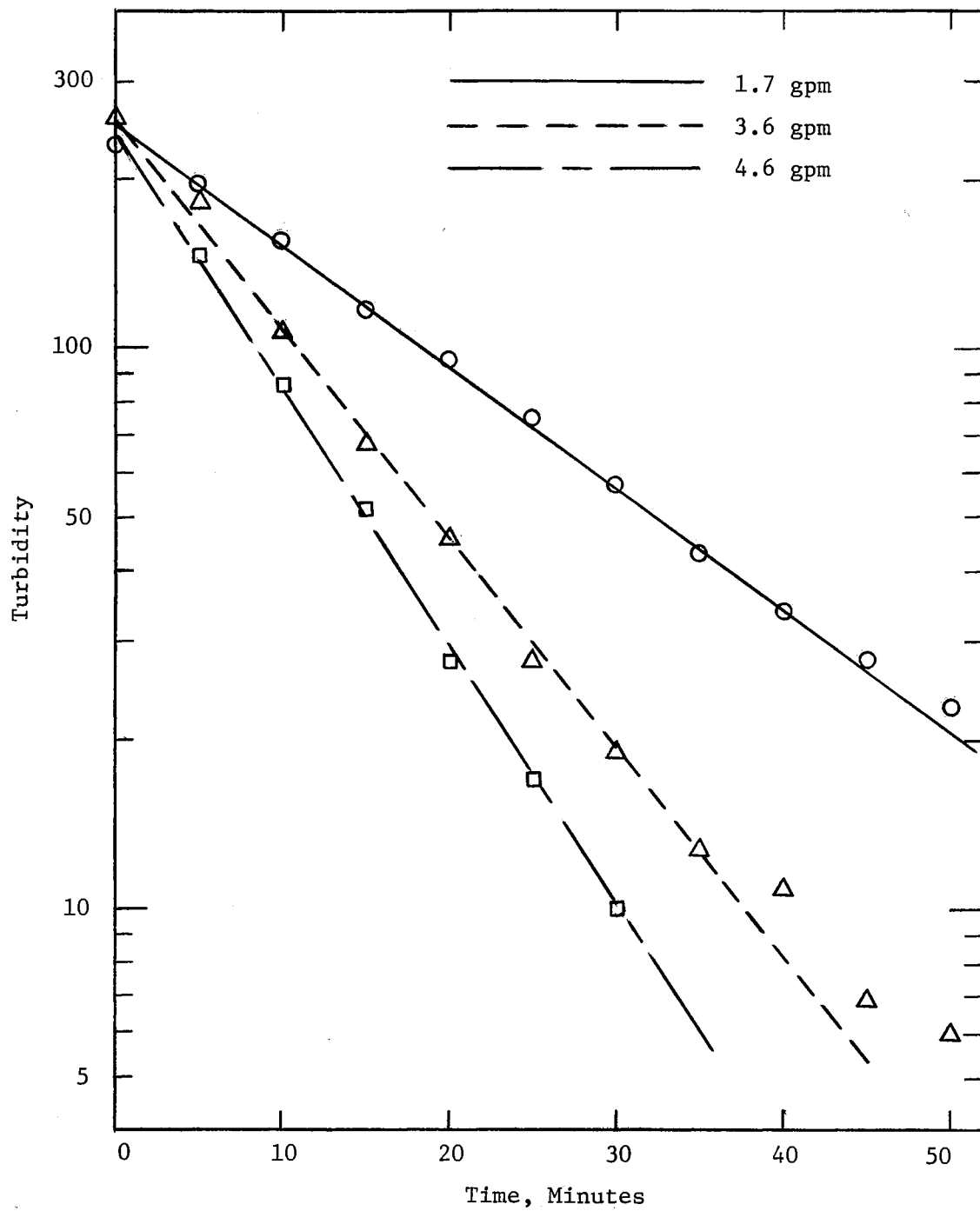

Figure 28. Continuous Recycle Results, Removal of Kaolinite Turbidity Without Coagulation

This may have been due to the difficulty of measurement at low turbidity levels.

2. Varied Materials

With the addition of a contamination trap, removal of all three clays was obtained. The results of the studies using Hydrocyclone #1 are presented in Figures 29 and 30. The contamination trap was used and no coagulating agents were added. Figure 29 represents turbidity removal and was constructed on a semi-log plot. The data plotted as straight lines, therefore, the turbidity removals followed first order kinetics. The removal rates are found by the slope of each line. These rates were calculated from these slopes and are presented in Table IV.

TABLE IV
REMOVAL RATES

Material	Solids	Turbidity
PRC	.086	.041
RMGC	.070	.045
Kaolinite	.068	.041

(Minutes⁻¹) of solids and turbidity for continuous recycle studies

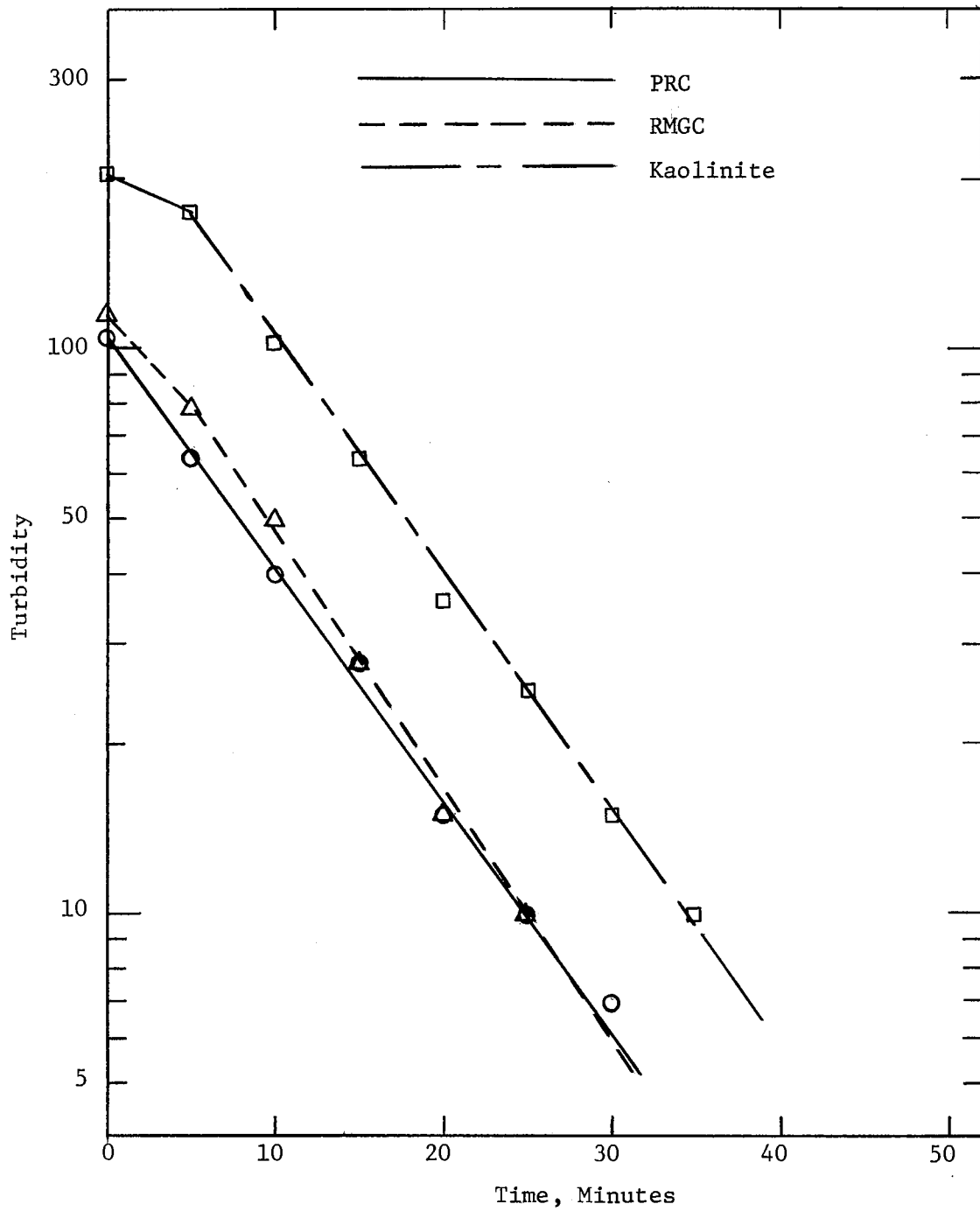

Figure 29. Continuous Recycle Results, Removal of Turbidity Using Closed Pot with Contamination Trap

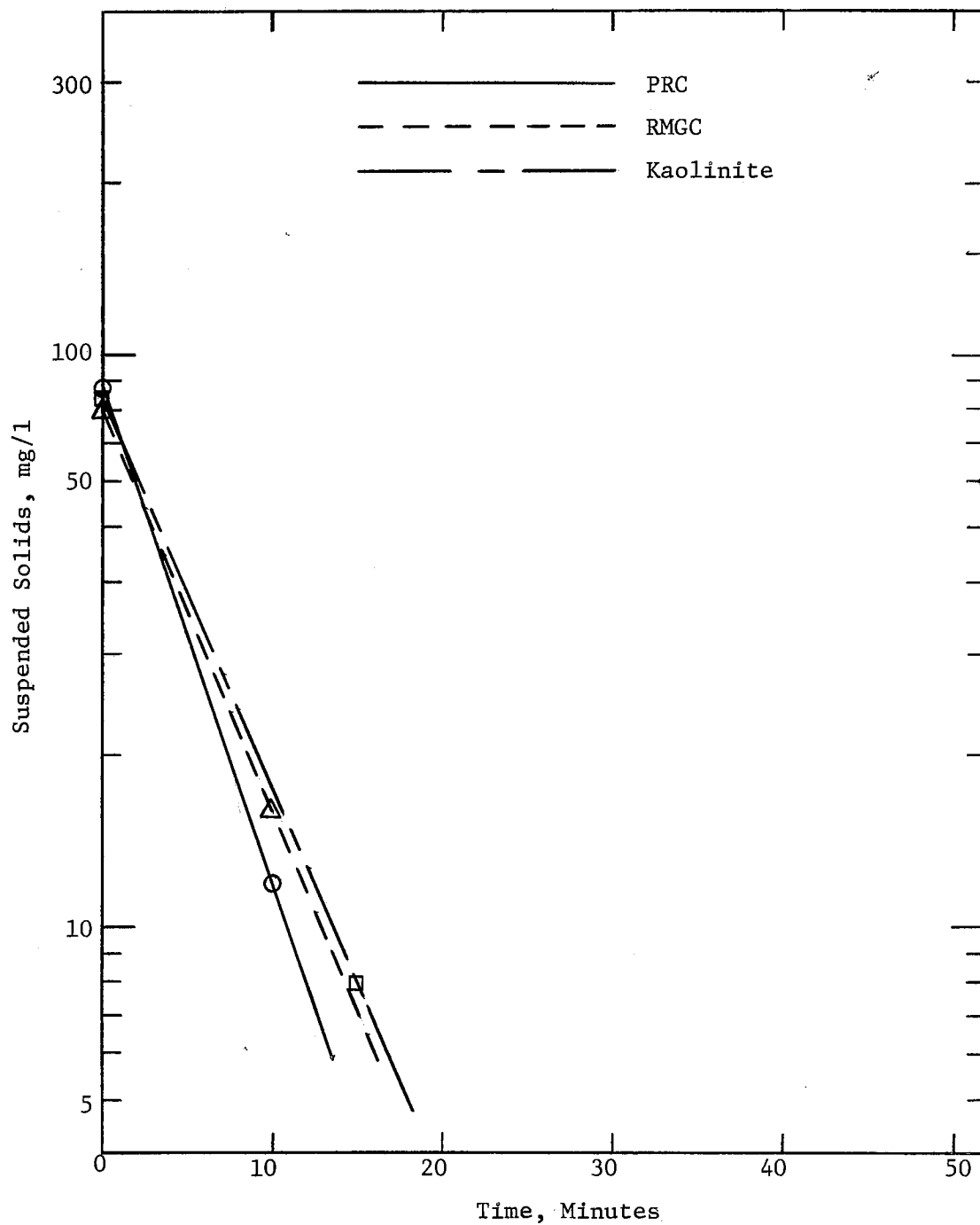

Figure 30. Continuous Recycle Results, Removal of Solids Using Closed Pot with Contamination Trap

Figure 30 shows the results of the same studies. The difference is that here solids concentration was used instead of turbidity. These lines also follow first order kinetics. The solids removal rates were calculated from these slopes and are also presented in Table IV.

It can be seen from Table IV that the removal rates based on turbidity were essentially the same for all three clays. The removal rates based upon suspended solids were much higher than those for turbidity, and they were not the same for each clay. The removal rate for PRC was the greatest and Kaolinite had the lowest removal rate.

Not shown in Figures 29 and 30 is the fact that a turbidity reading of zero was achieved for each clay using the closed pot with contamination trap. Also, it was noted that the solids measurements reached zero 15 to 20 minutes sooner than the turbidity reached zero.

Effects of Coagulant Agents

The use of coagulating agents was investigated to determine the possibility of building up solid sizes which the hydrocyclone could remove efficiently. In the continuous recycle with trap runs, alum was used as the coagulating agent. The system was not flocculated prior to the experiment. This was to see if the floc would develop in the system. No floc buildup was observed. Table III shows that the overall effect of the coagulation was detrimental to hydrocyclone performance.

In the single-pass studies a polyelectrolyte, C-31, was used as a coagulant aid with the alum to strengthen the floc particles. The clay slurries were flocculated prior to being pumped through the hydrocyclone. However, it was observed that the floc particles were completely broken up on the first pass. Again, coagulation did not

improve hydrocyclone performance.

Jar test studies were made to determine the optimum coagulant dosages for each case. The results of these studies are presented in Table V.

TABLE V
OPTIMUM COAGULANT DOSAGES

Clay	Alum mg/l	Alum + C-31 mg/l
PRC	150	150-75
RMGC	230	230-45
Kaolinite	230	230-45

CHAPTER V

DISCUSSION

This was a feasibility study using an existing hydrocyclone to study the capability of removing particles which cause turbidity. The most obvious result is that the closed pot configuration without the contamination trap is not feasible. The results show that only the very large particles are kept in the collection pot. The rest of the particles, especially the smaller turbidity causing particles, escape from the pot back into the system very easily.

On the other hand, considerable promise was shown using the closed pot with trap and the open underflow configurations. The closed pot configuration with contamination trap shows potential for a portable water treatment system. The system would be especially effective if a diatomaceous earth filter was used in conjunction with the hydrocyclone. For example, a mobile treatment unit could be made that would enable the Army to treat water in the field, instead of carrying potable water over long distances.

There were many indications that turbidity removal and solids removal were two different parameters. For instance, the hydrocyclone gave different performances on the different clays with respect to solids, but the same performance on each clay with respect to turbidity. The single-pass studies show that the solids were concentrated and separation was achieved to varying extent with each clay. The

continuous recycle with trap runs show that turbidity was removed at the same rate for each clay, while there was some difference in the rate of solids removal. It was noted that the turbidity in most cases reached a reading of zero in the continuous recycle with trap studies. However, the solids reached zero 15 to 20 minutes earlier than the turbidity became zero. This indicates that at least 25 units of the turbidity were caused by particles small enough to pass through the .45 micron membrane filter. It seems then, that turbidity should be used to determine the effectiveness of a hydrocyclone for water treatment since turbidity is the main parameter in water treatment.

There is a definite decrease in efficiency of separation and concentration with each succeeding pass, as shown by the single-pass studies. This indicates that the larger particles are removed efficiently while the smaller particles are removed less efficiently. This is supported by a single-pass study conducted by the Mechanical Engineering Department for the G. H. Tennant Company (19). The important difference in this data is that the separation efficiency was determined by using a HIAC particle counter to count the number of particles upstream and downstream of the hydrocyclone. Here the solids were AC fine test dust, which is a silicone oxide. Figure 31 represents the results from that study and shows that separation efficiency decreases with particle size. This is consistent with the fact that much lower concentration and separation efficiencies were obtained after the first pass, that is, after the larger particles had been taken out.

Since it is probable that turbidity is caused by small particles which are present in all the clays, a successful hydrocyclone must be

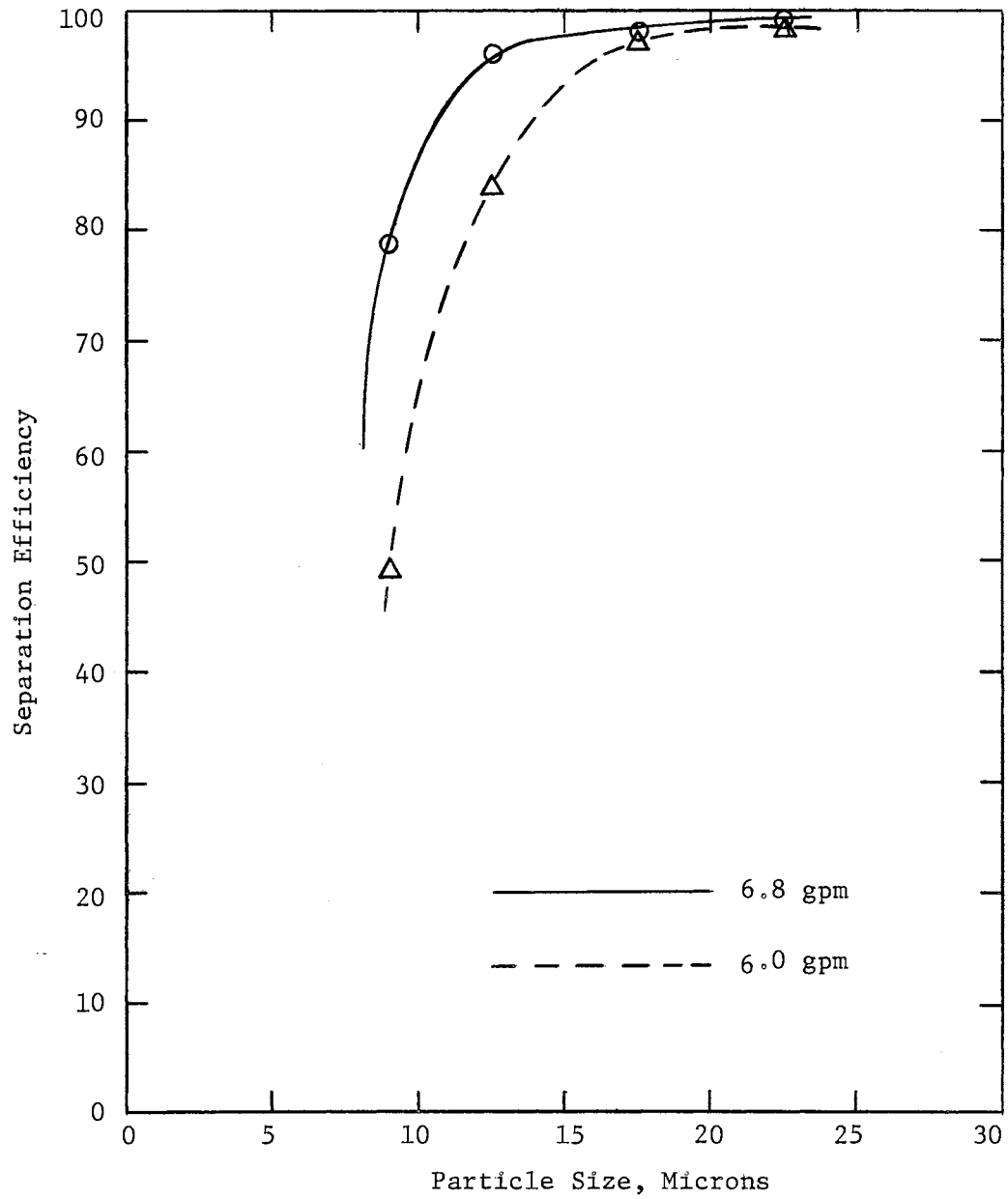

Figure 31. Effect of Flow Rate on the Separation Efficiency of the Hydrocyclone with Contamination Trap (AC Fine Test Dust)

designed specifically for the removal of the small particles. Several approaches to new designs are suggested by this study. The continuous recycle studies with trap indicate that efficiency increases as the flow rate (and power consumption) increases. Figure 31 also shows an increase in efficiency with an increase in flow rate. There is probably one flow rate beyond which greater flow rates cease to add to the performance of the hydrocyclone. It is also possible that there is a peak flow rate, beyond which the efficiency of the hydrocyclone actually decreases.

The studies made with Hydrocyclone #2 indicate that the separation efficiencies for small particle sizes can also be improved by reducing the size of the separator. The smaller hydrocyclone gave much higher concentration percentages.

Consequently, a full-scale hydrocyclone clarification system would probably consist of several hydrocyclone "banks" in series. Each bank would consist of numerous identical hydrocyclones in parallel. The hydrocyclones in the first bank would be the largest, and would be used to remove the larger particles. As the series progressed, the hydrocyclone size would become smaller in order to remove the smaller particles. Since a smaller hydrocyclone necessitates smaller flow rates, the hydrocyclone banks at the beginning of the series would consist of fewer individual units than the banks at the end of the series.

A series of experiments using alum and a cationic polyelectrolyte as coagulating agents were also conducted. In all cases, the coagulating agents did not improve the performance of the hydrocyclone. When the coagulation agents were added without flocculation, floc

particles were not able to form in the hydrocyclone. When the clay slurry was flocculated prior to being pumped through the hydrocyclone, the floc particles were immediately broken up and did not reform. The shear stresses completely broke up the flocs even though polyelectrolyte was added to strengthen the floc particles. In order for coagulating chemicals to improve the performance of the hydrocyclone, they would have to form exceptionally shear resistant floc. It is possible that these chemicals exist, however, it was beyond the scope of this study to attempt finding these chemicals.

CHAPTER VI

CONCLUSIONS

The results of this investigation support the following conclusions:

(1) The rate of turbidity removal rather than the rate of solids removal should be the parameter for determining the effectiveness of the hydrocyclone for water treatment use.

(2) To be effective, a hydrocyclone must be specifically designed for small particle removal.

(3) The hydrocyclone should be operated at its optimum flow rate.

(4) Separation efficiency for small particle sizes can be improved by reducing the size of the separator.

(5) The closed pot hydrocyclone configuration without a contamination trap is not feasible for water treatment.

(6) The closed pot with trap and the open underflow configurations show sufficient promise as clarifiers in water treatment that further study and development of these configurations is merited.

CHAPTER VII

SUGGESTIONS FOR FUTURE STUDY

From the results of this investigation, the following suggestions are made for the study of the hydrocyclone in water clarification:

- (1) The design and construction of hydrocyclones specifically for colloidal particle removal.
- (2) The investigation of coagulation chemicals to determine if any exist that will produce shear resistant floc particles.
- (3) The study of the performance of several different hydrocyclones in series.
- (4) The study of the combination of hydrocyclones with different types of filter systems.

SELECTED BIBLIOGRAPHY

- (1) Aitken, I.M.E. "Reflections on Sedimentation Theory and Practice-Part 1." Effluent and Water Treatment Journal, 7, (1967), 226-231, 267 and 269-273.
- (2) Hirsch, A. A. "Functional Effluent Baffling - A Key to Settling Basin Efficiency." Water and Sewage Works, 113, (1966), Reference No. R. 141 - R. 142 and R. 145 - R. 150.
- (3) Tekippe, R. J. and J. L. Cleasby. "Model Studies of a Peripheral-Feed Settling Tank." Jour. San. Engr. Div., ASCE, 94, (1968), SA 1, 85-102.
- (4) Mărută, A. "Density Currents in Settling Basins." Stud. Hidraul. Experiment, Bucharest, (1959), 299-310. Abstracted by Water Pollution Abstracts, 38, (1965), #1985.
- (5) Fuller, H. E. "Sludge Handling in a Rectangular Clarifier." TAPPI, 50, (1967), No. 10, 82A-84A.
- (6) Culp, Gordon L., Kou-Ying Hsiung, and Walter R. Conley. "Tube Clarification Process." Jour. San. Engr. Div., ASCE, 95, SA 5, (1968), 829-847.
- (7) Hansen, S. P. and G. L. Culp. "Applying Shallow Depth Sedimentation Theory." Jour. American Water Works Association, 59, (1967), 1134.
- (8) Culp, G. and W. Conley. "High-Rate Sedimentation with the Tube-Clarifier Concept." Water Quality Improvement by Physical and Chemical Processes, University of Texas Press, (1970).
- (9) Dresser, H. G. "Trays Nearly Triple Settling Tank Capacity." Engineering News Record, 147, (November 29, 1951), 32.
- (10) Dick, R. I. Discussion, Jour. San. Engr. Div., ASCE, 96, (1970), SA 4.
- (11) Haas, P. A., E. O. Nurmi, M. E. Whatley, and J. R. Engle. "Midget Hydrocyclones Remove Micron Particles." Chemical Engineering Progress, 53, (1957), 4, 203-207.
- (12) Tangel, O. F. and R. J. Brison. "Wet Cyclones." Chemical Engineering, 62, (1955), 2, 234-238.

- (13) Daughy, F.T.C. "Liquid Cyclones in the Chemical Industry." British Chemical Engineering, 8, (1963), 616-617.
- (14) Barskii, V. G. "Hydrocyclones and Their Possible Use in Water-Treatment Stations." Novaya Tekh. Zhil.-Kommun. Khoz. Vodosn. Kanaliz., Nauch.-Tekh. Inform. Sb., No. 2, (1963), 51-62. Abstracted by Water Pollution Abstracts, 38, (1965), #1579.
- (15) Molyneux, F. "The Daynor in Water Clarification." Water and Water Engineering, 67, (1963), 436-439.
- (16) Maciula, L. Andrew and Robert E. Reed. Stillwater, Oklahoma, Assignors to Oklahoma State University, Stillwater, Oklahoma, Patent 3,529,724.
- (17) Michaels, A. S. and O. Morelos. "Polyelectrolyte Adsorption by Kaolinite." Industrial and Engineering Chemistry, 47, (1955), 1801-1808.
- (18) Marks, B. Dan and T. Allan Haliburton. "Final Report - A Salt-Lime Soil Stabilization Feasibility Study." Conducted for the State of Oklahoma, Department of Highways, (June, 1970).
- (19) Tiederman, W. G., L. A. Maciula, and R. E. Reed. "6 GPM (Water-Dirt) Hydrocyclone - A Feasibility Study for the G. H. Tennant Company." Oklahoma State University, Office of Engineering Research, Report No. ER-70-I-18, (June 1, 1970).

APPENDIX

TABLE OF TERMS

D_c = Maximum diameter of hydrocyclone

D_i = Feed inlet diameter

D_o = Vortex finder diameter

D_u = Diameter of underflow (minimum cone diameter)

L = Length of cone

α = Alpha, cone angle

ϕ = Phi, subcone angle

D_{Ri} = Inside diameter of contamination trap return flow tube

D_{Ro} = Outside diameter of contamination trap return flow tube

L_R = Length of contamination trap return flow tube

VITA

2

Thomas James Cobb

Candidate for the Degree of

Master of Science

Thesis: A STUDY OF HYDROCYCLONE SEPARATION IN WATER CLARIFICATION

Major Field: Bioenvironmental Engineering

Biographical:

Personal Data: Born November 22, 1947, in Frankfurt, Germany, the son of Henry and Jo Ann Cobb.

Education: Graduated from Grand Forks Central High School, Grand Forks, North Dakota, in 1965; received the Degree of Bachelor of Science in Civil Engineering from Oklahoma State University, Stillwater, Oklahoma, in May, 1970; received the Master of Science Degree from Oklahoma State University, Stillwater, Oklahoma, in May, 1971.

Professional Experience: Undergraduate Research Assistant, Oklahoma State University, June, 1969 - January, 1970.

Membership in Professional Societies: American Society of Civil Engineers, American Water Works Association, Chi Epsilon.